

Gate Burton Energy Park Environmental Statement

Volume 3, Appendix 13-E: Framework Construction Traffic Management Plan ([Change Request Version](#))

Document Reference: EN010131/APP/3.3

[January-October 2023](#)

APFP Regulation 5(2)(a)

Planning Act 2008

Infrastructure Planning (Applications: Prescribed Forms and Procedure) Regulations 2009

Annex C. Abnormal Vehicles Route Access Swept Paths (Grid Connection Corridor)

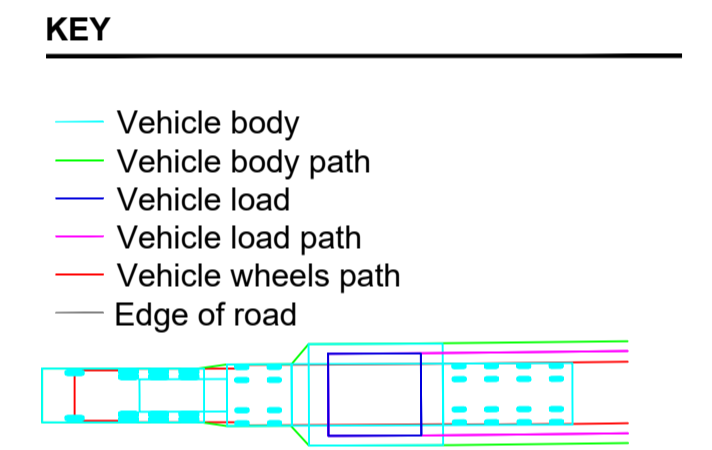
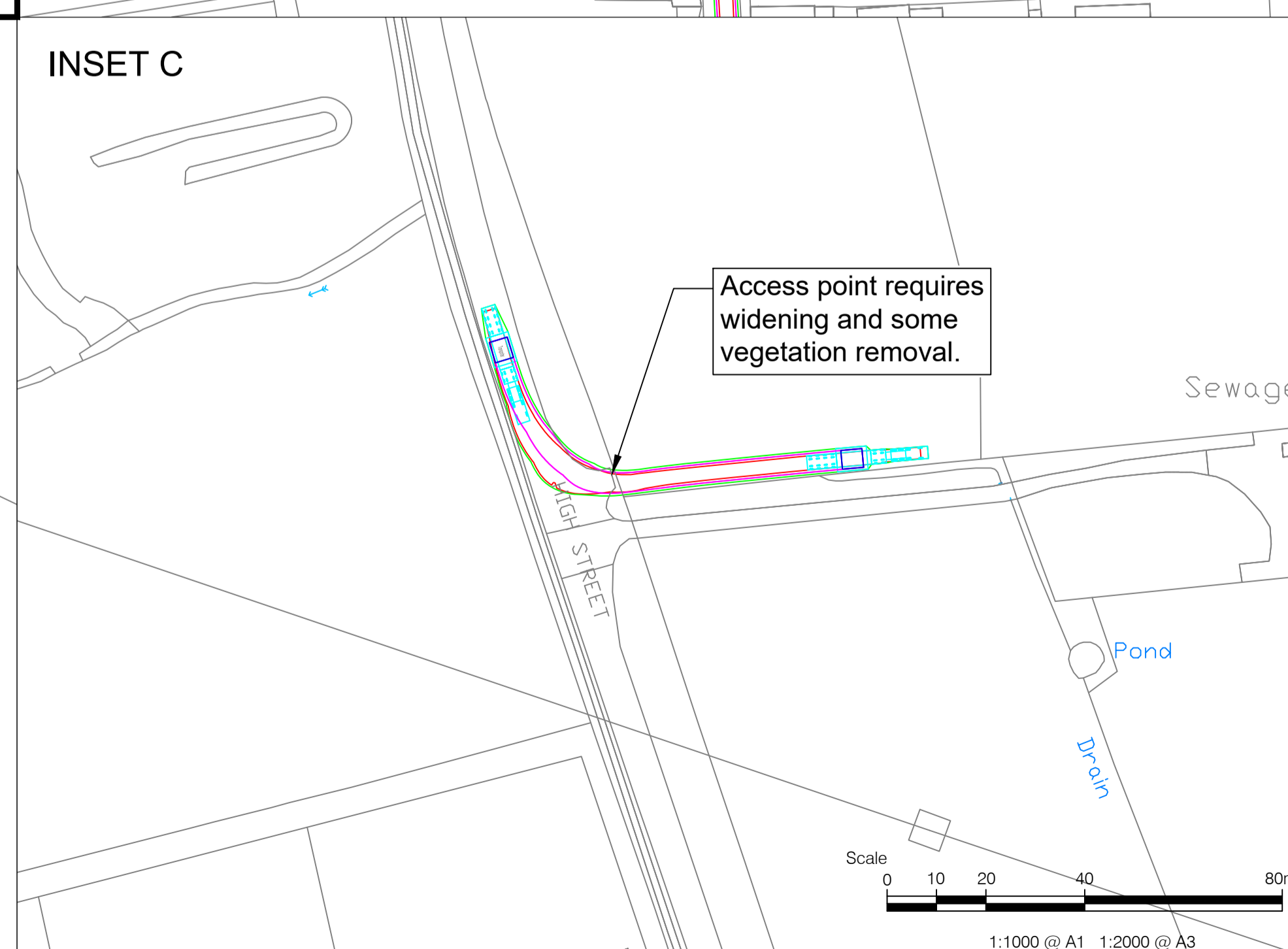
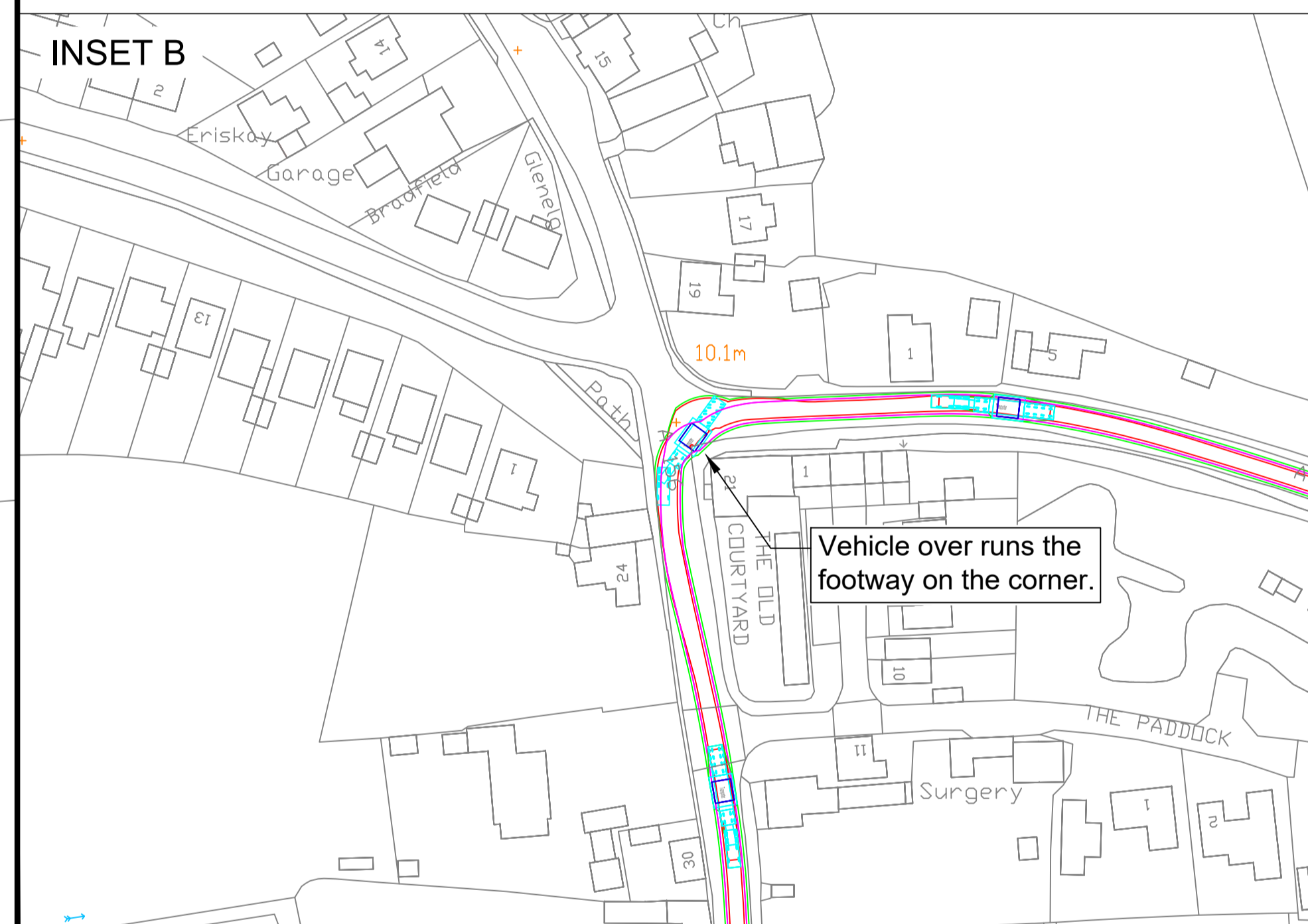
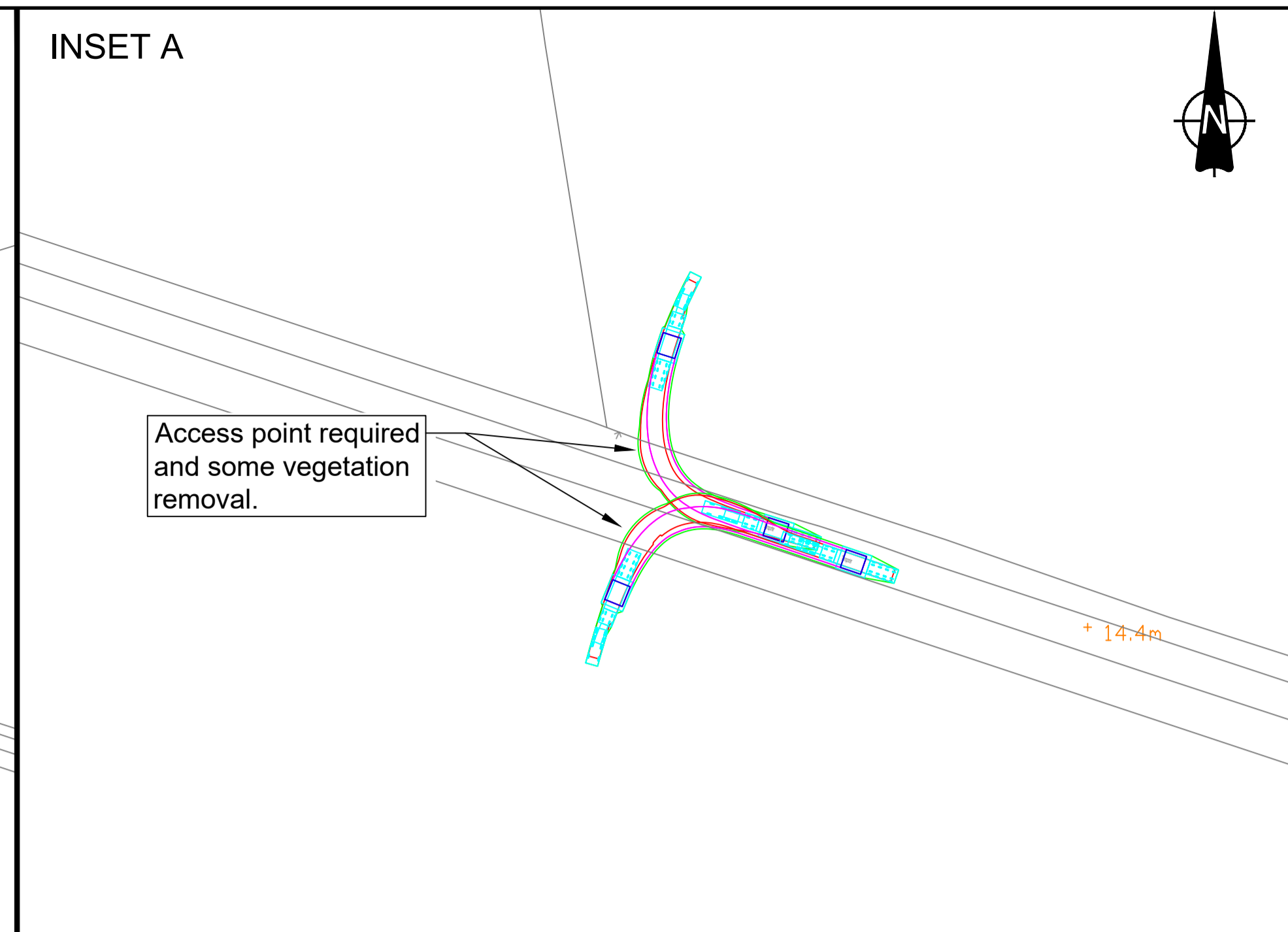
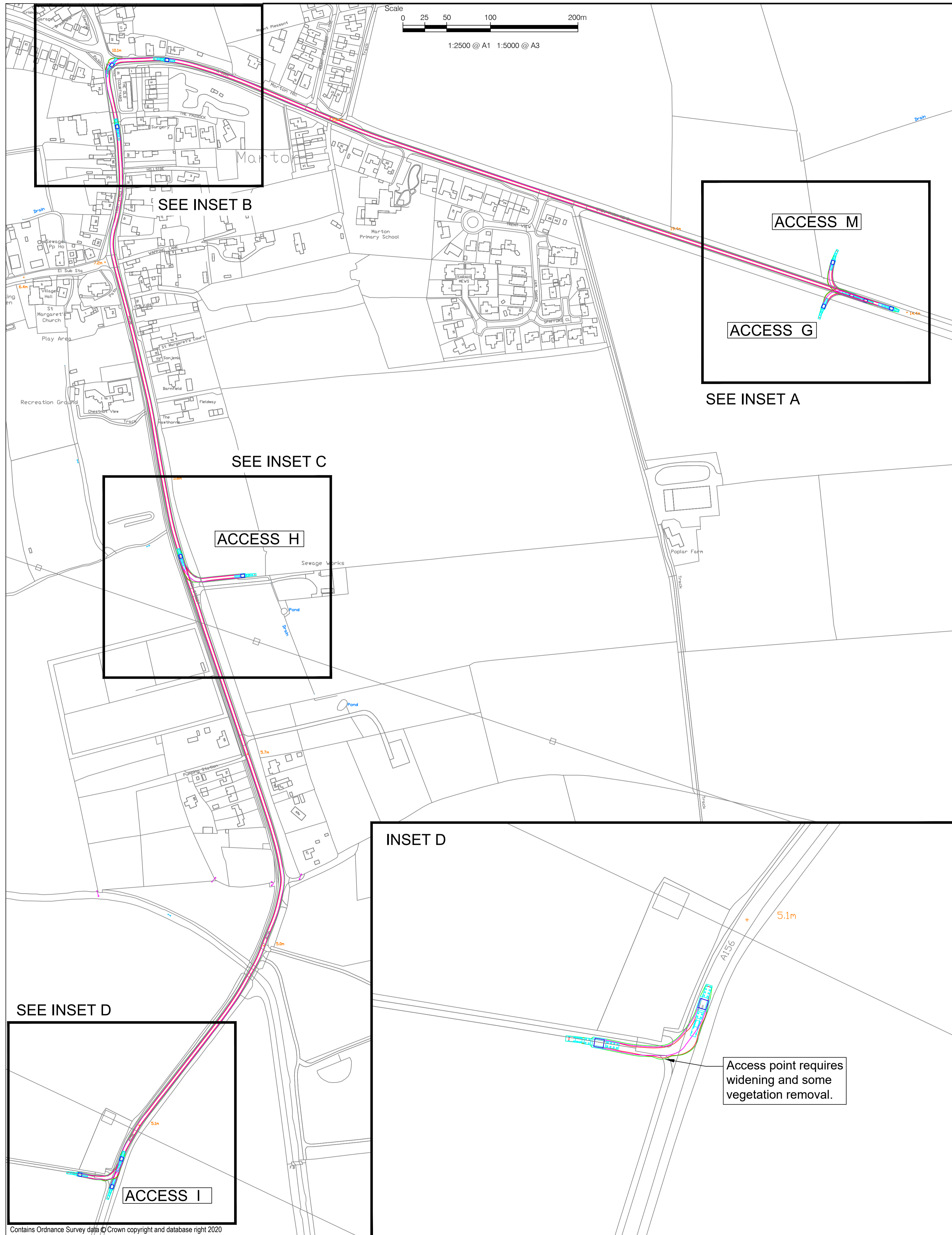

Transporter

Overall Length	24.560m
Overall Width	4.700m
Overall Body Height	3.368m
Min Spiky Ground Clearance	0.285m
Max Track Width	2.479m
Lock to lock time	6.00s
Kerb to Kerb Turning Radius	6.790m

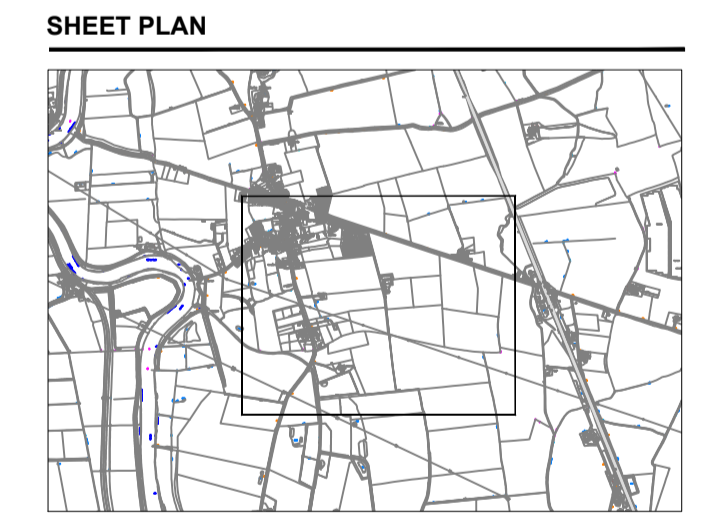

ISSUE/REVISION

I/R	DATE	DESCRIPTION

This drawing has been prepared for the use of AECOM's client. It may not be used, modified, reproduced or relied upon by third parties, except as agreed by AECOM or as required by law. AECOM accepts no responsibility, and denies any liability whatsoever, to any party that uses or relies on this drawing without AECOM's express written consent. Do not scale this document.

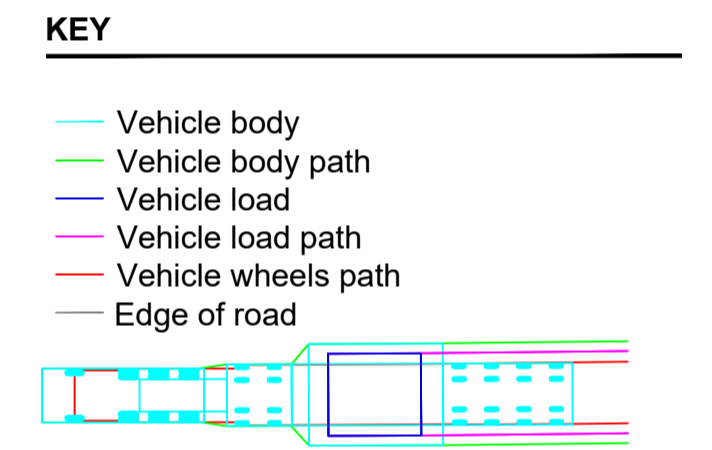
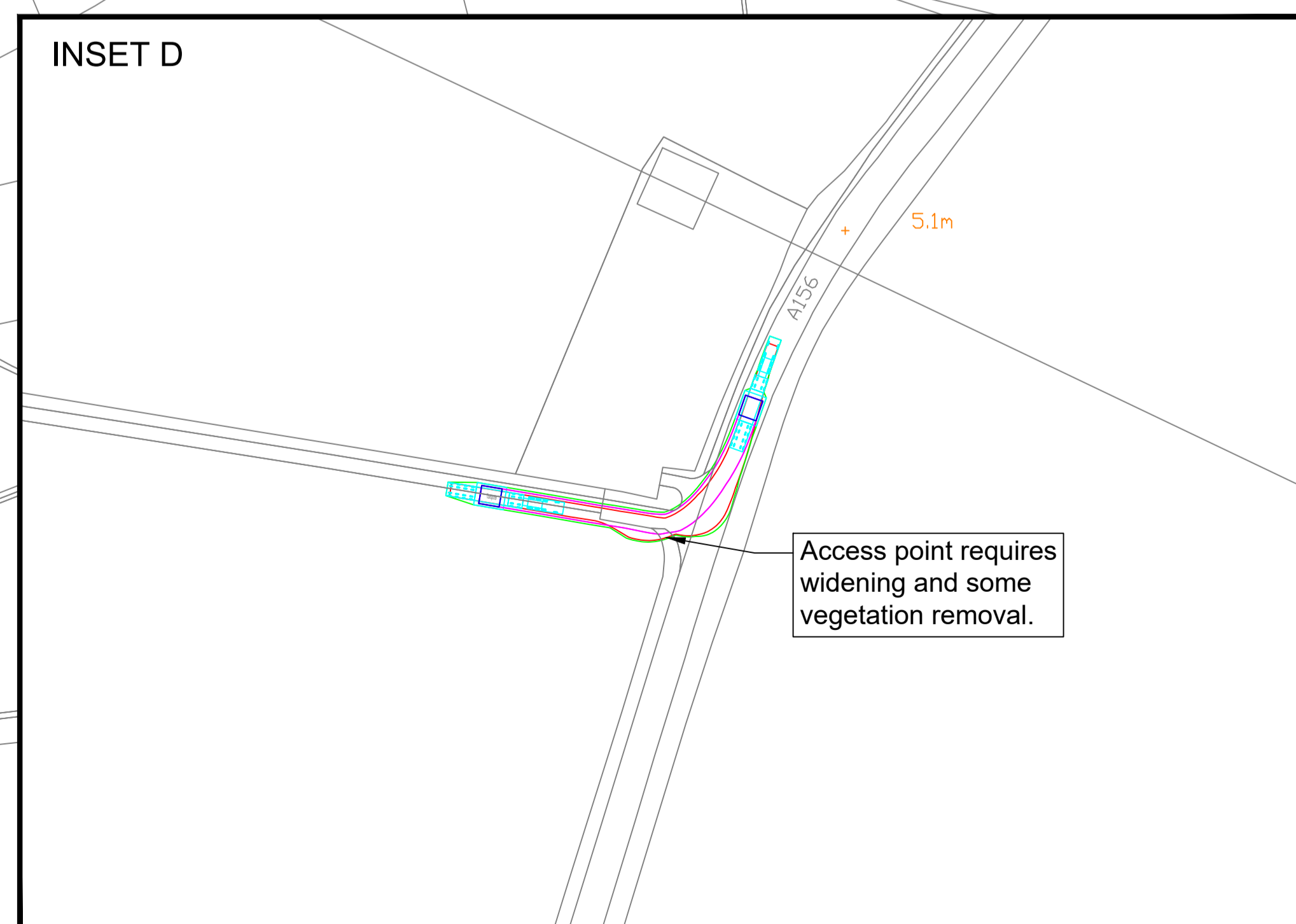
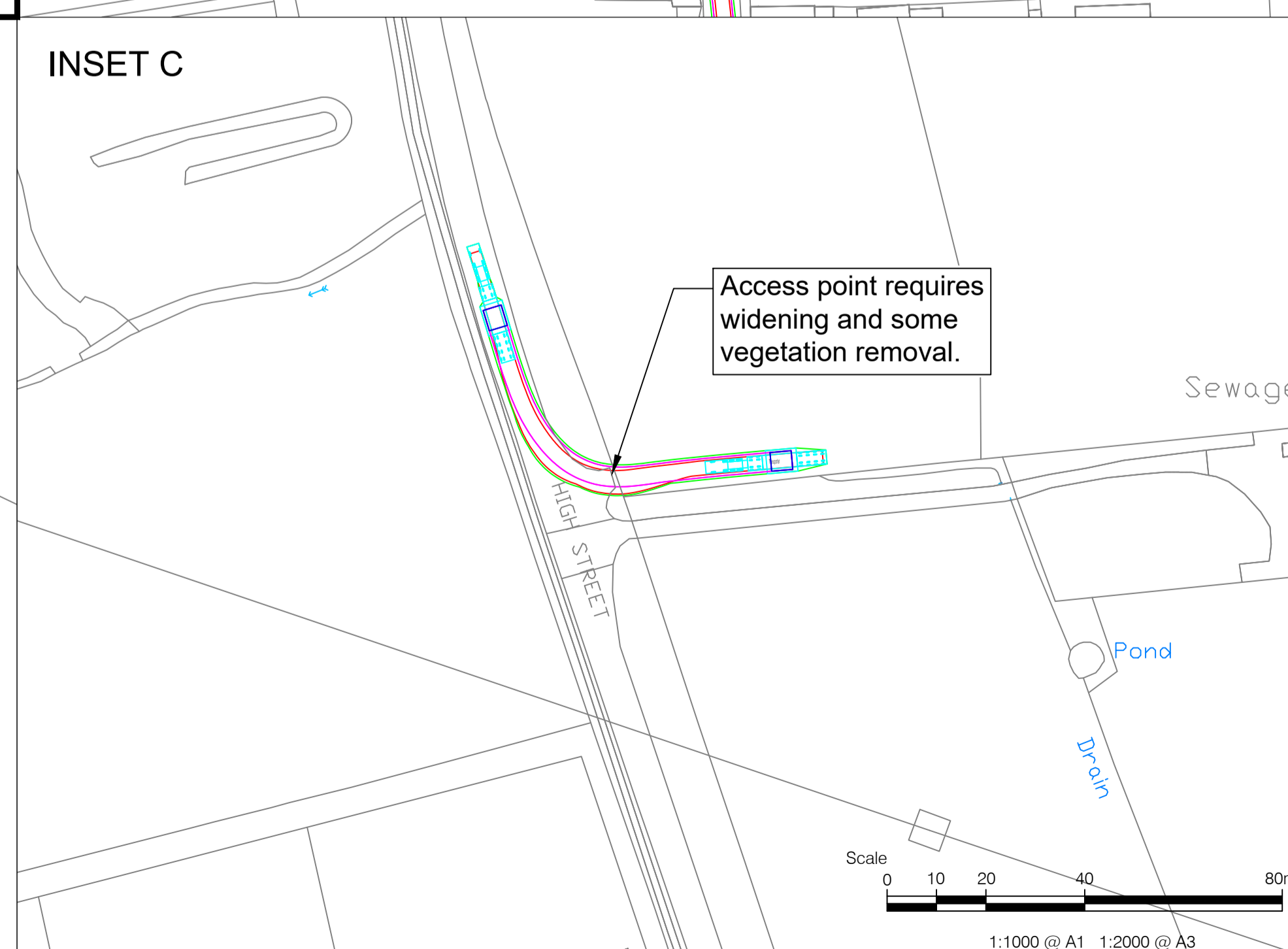
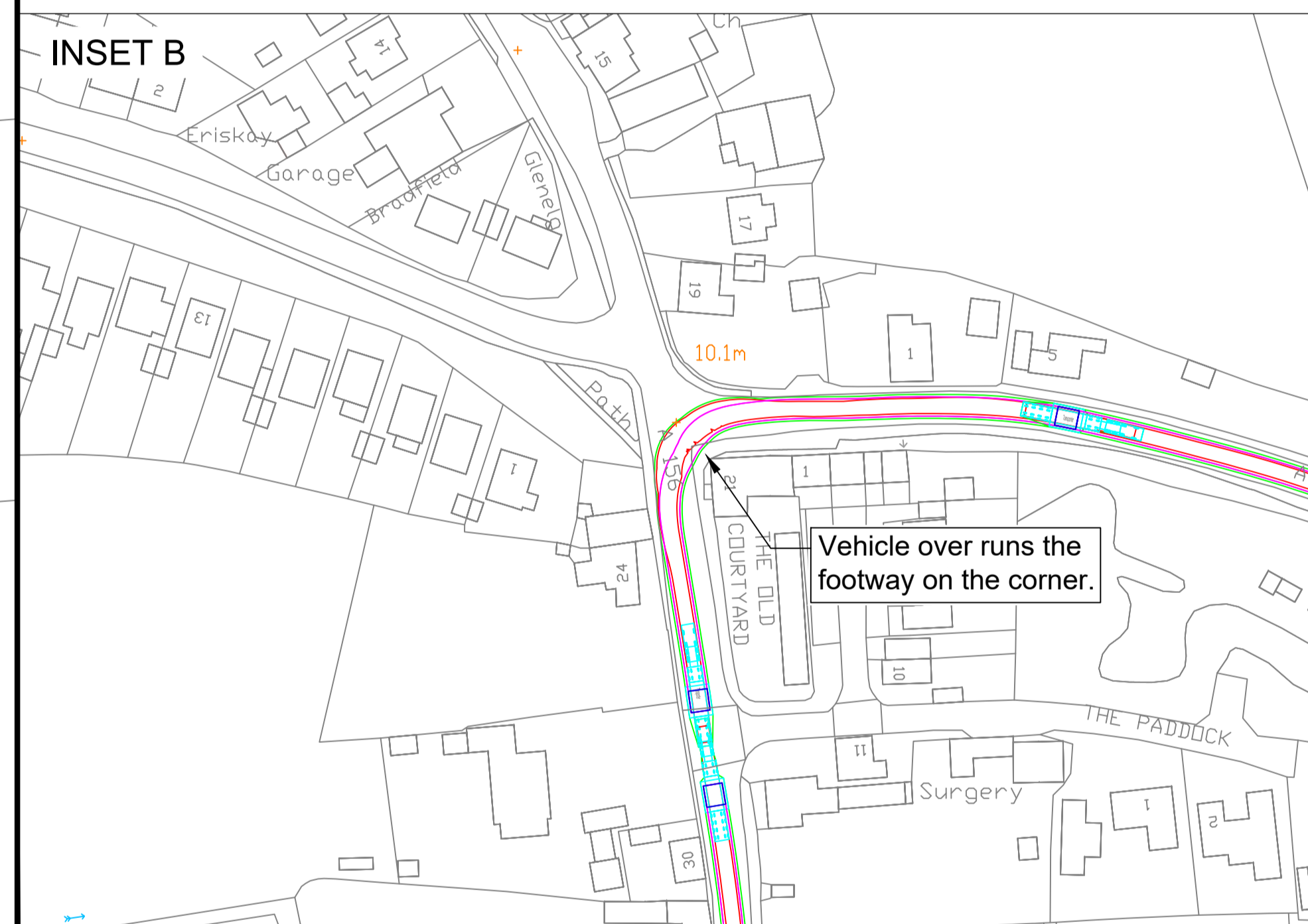
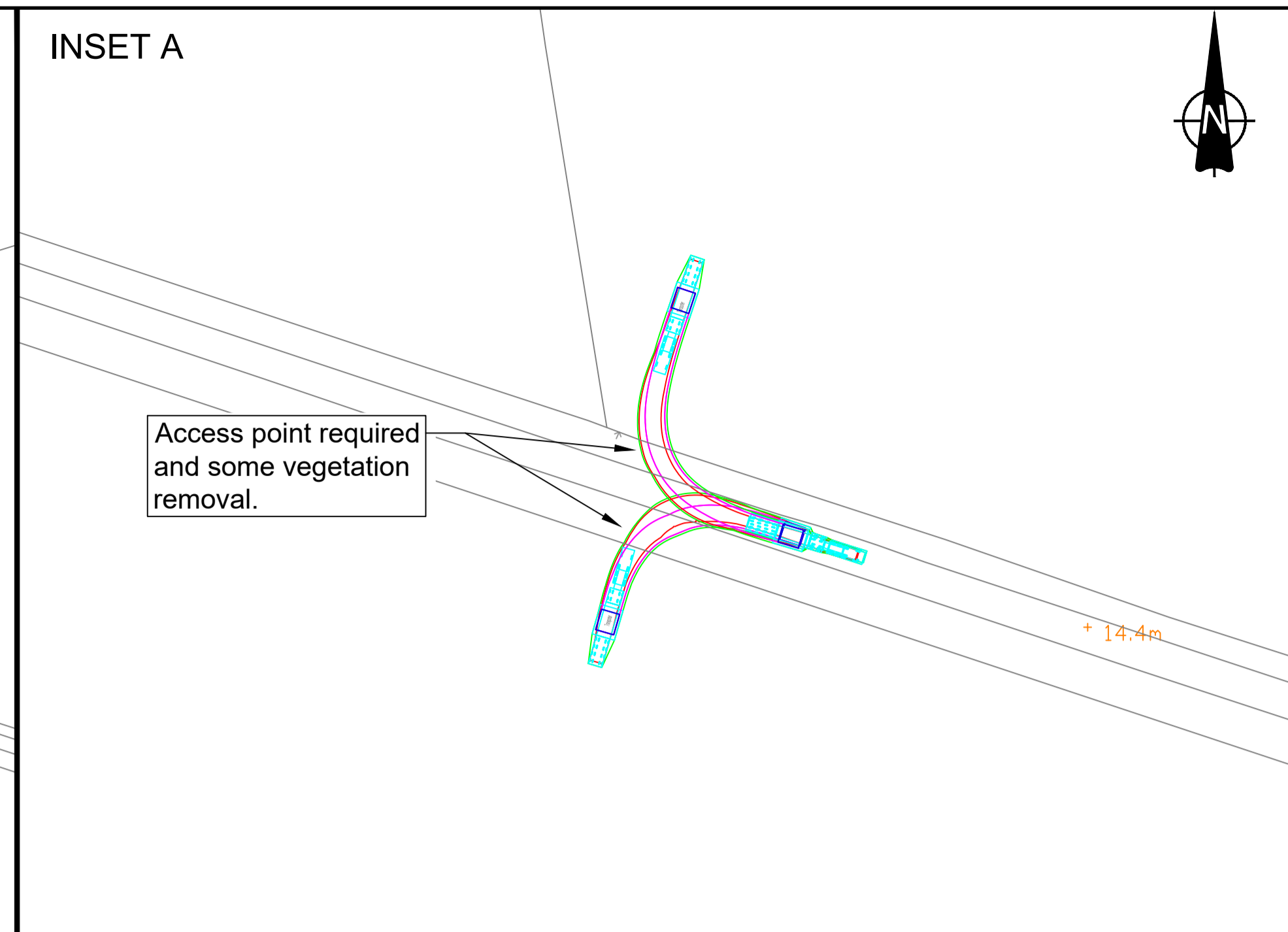
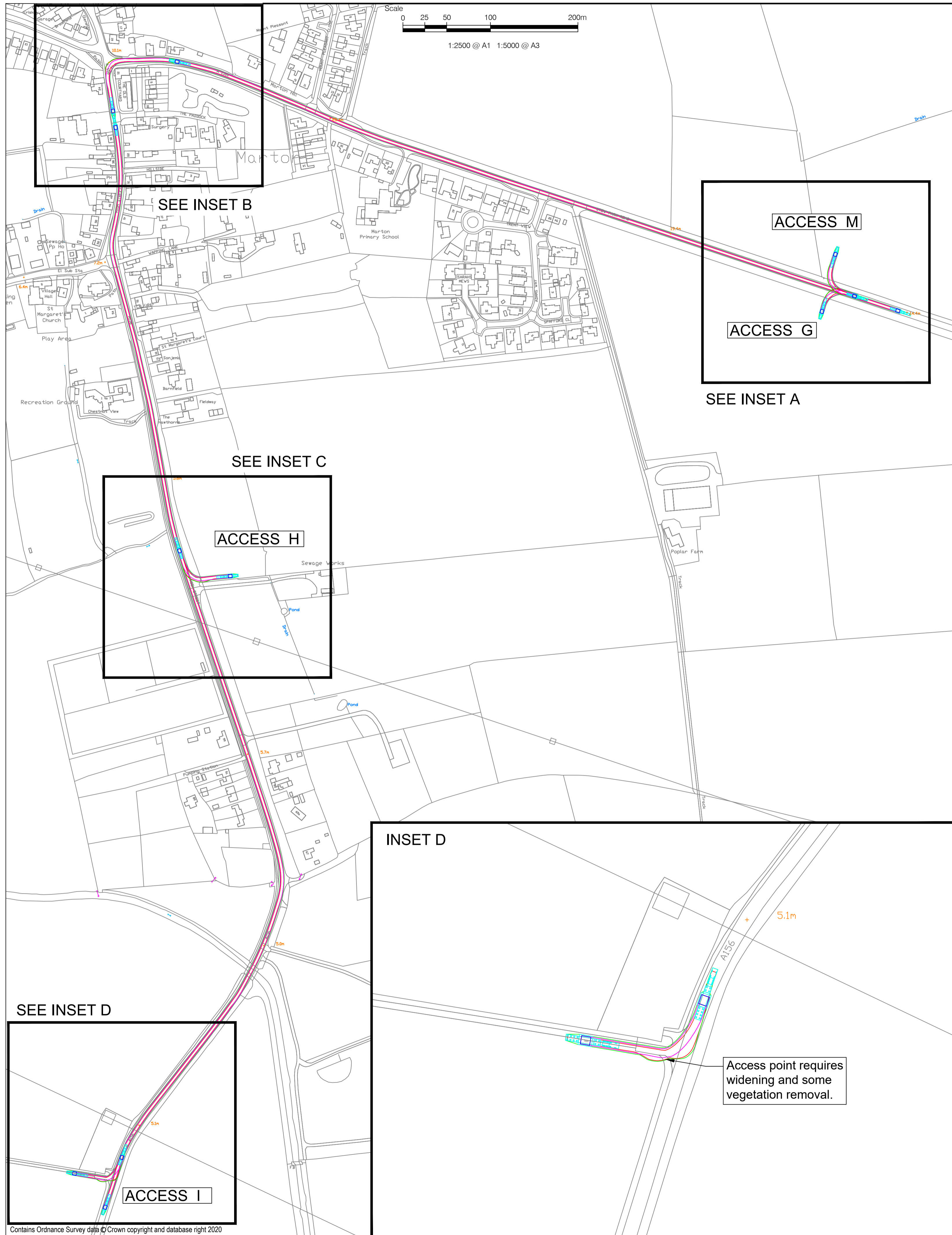

Transporter

Overall Length	24.560m
Overall Width	4.700m
Overall Body Height	3.368m
Min Body Ground Clearance	0.285m
Max Track Width	2.479m
Lock to lock time	6.00s
Kerb to Kerb Turning Radius	6.790m

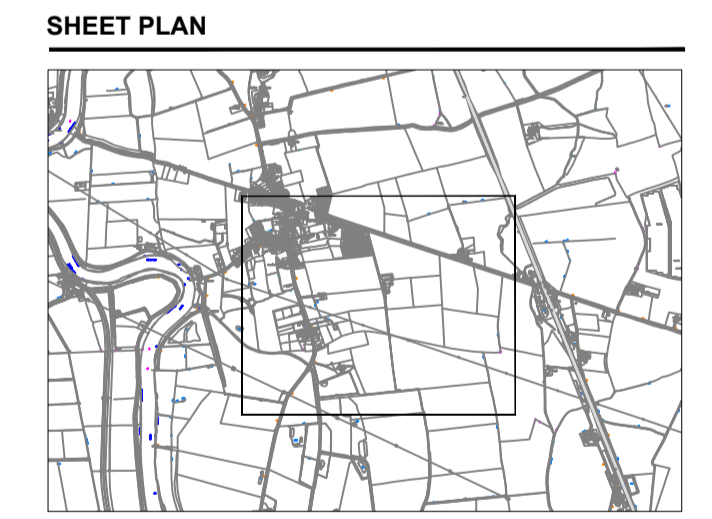

ISSUE/REVISION

I/R	DATE	DESCRIPTION

This drawing has been prepared for the use of AECOM's client. It may not be used, modified, reproduced or relied upon by third parties, except as agreed by AECOM or as required by law. AECOM accepts no responsibility, and denies any liability whatsoever, to any party that uses or relies on this drawing without AECOM's express written consent. Do not scale this document.

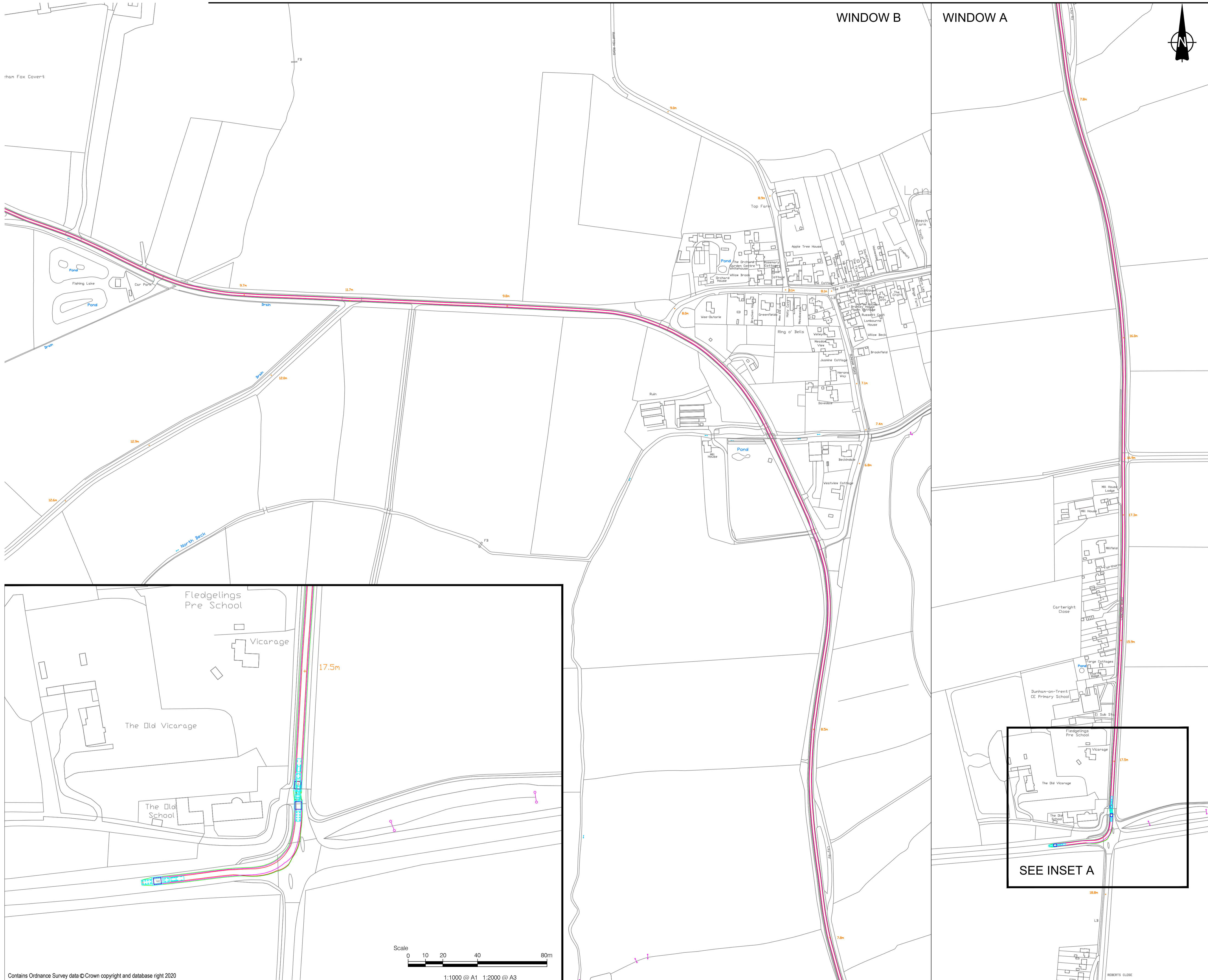

Contains Ordnance Survey data © Crown copyright and database right 2020

1:1000 @ A1 1:2000 @ A3

WINDOW B

WINDOW A



PROJECT

Gate Burton Energy Park
 Development Consent Order

CLIENT

Low Carbon

CONSULTANT

AECOM
 Saxon House, 27 Duke Street
 Chelmsford, Essex, CM1 1HT
 01245 771200 tel 01245 476121 fax

GENERAL NOTES

INBOUND DELIVERY VEHICLE TRACKING

KEY

- Vehicle body
- Vehicle body path
- Vehicle load
- Vehicle load path
- Vehicle wheels path
- Edge of road

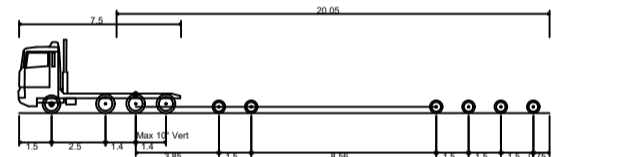
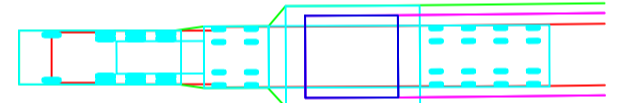

Transporter
 Overall Length 24.560m
 Overall Width 4.700m
 Overall Body Height 3.368m
 Min Body Ground Clearance 0.285m
 Max Track Width 2.479m
 Lock to lock time 6.00s
 Kerb to Kerb Turning Radius 6.790m

SHEET PLAN

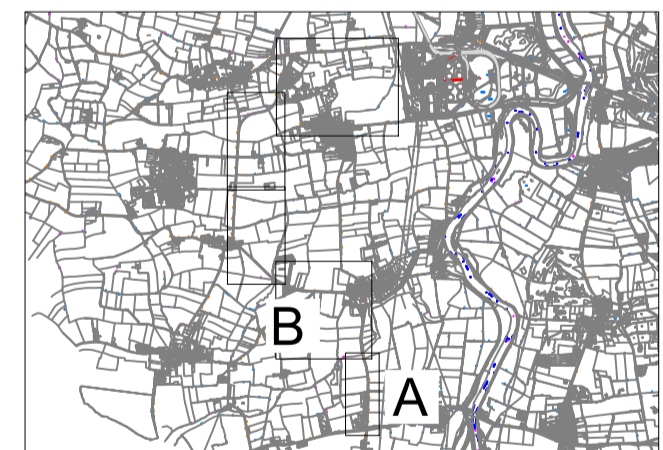

ISSUE/REVISION

I/R	DATE	DESCRIPTION

PROJECT NUMBER

60664324

SHEET TITLE

Swept Path Analysis - Cable Route AILs
 Route 2 - A57 Cottam Road
 Accesses O and P. Sheet 1 of 6

SHEET NUMBER

60664324-75-TRA-402

This drawing has been prepared for the use of AECOM's client. It may not be used, modified, reproduced or relied upon by third parties, except as agreed by AECOM or as required by law. AECOM accepts no responsibility, and denies any liability whatsoever, to any party that uses or relies on this drawing without AECOM's express written consent. Do not scale this document.

SEE INSET A

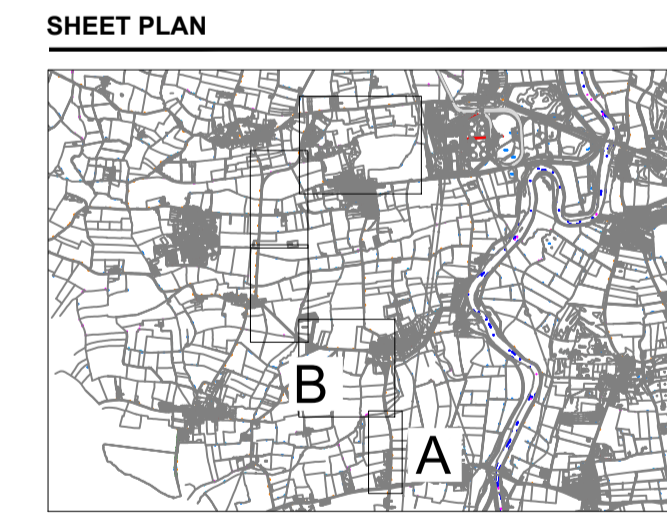
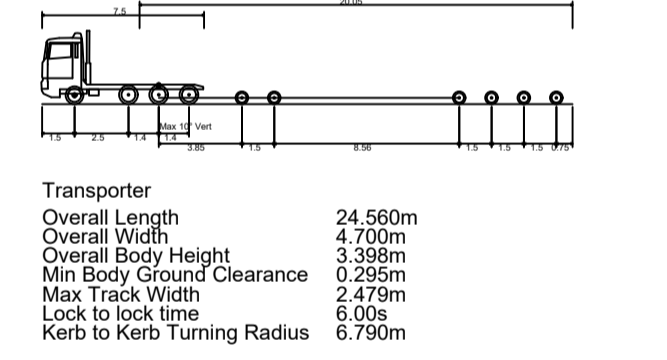
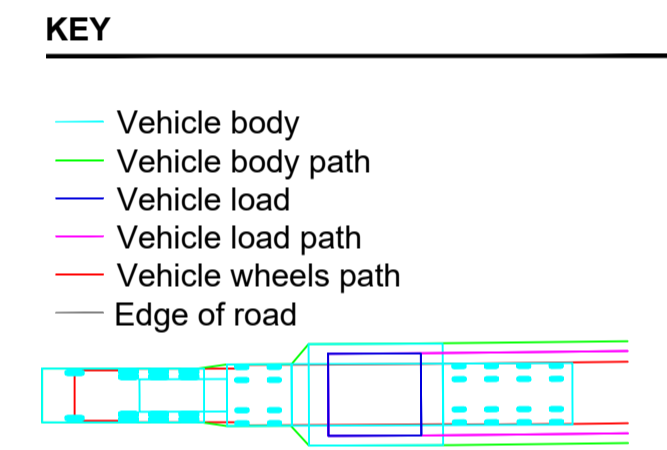
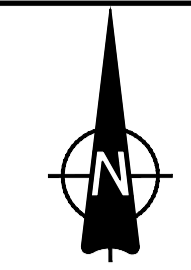
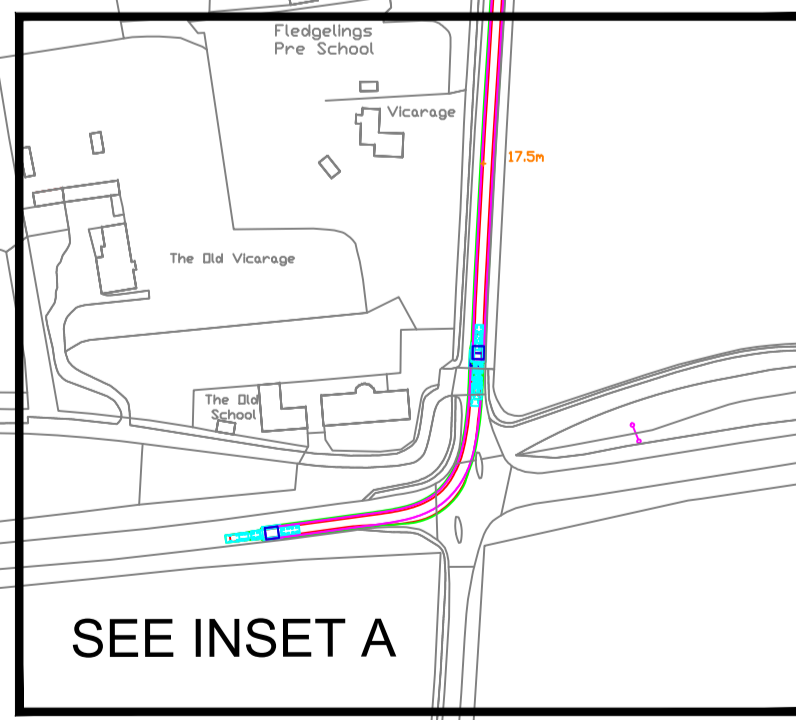
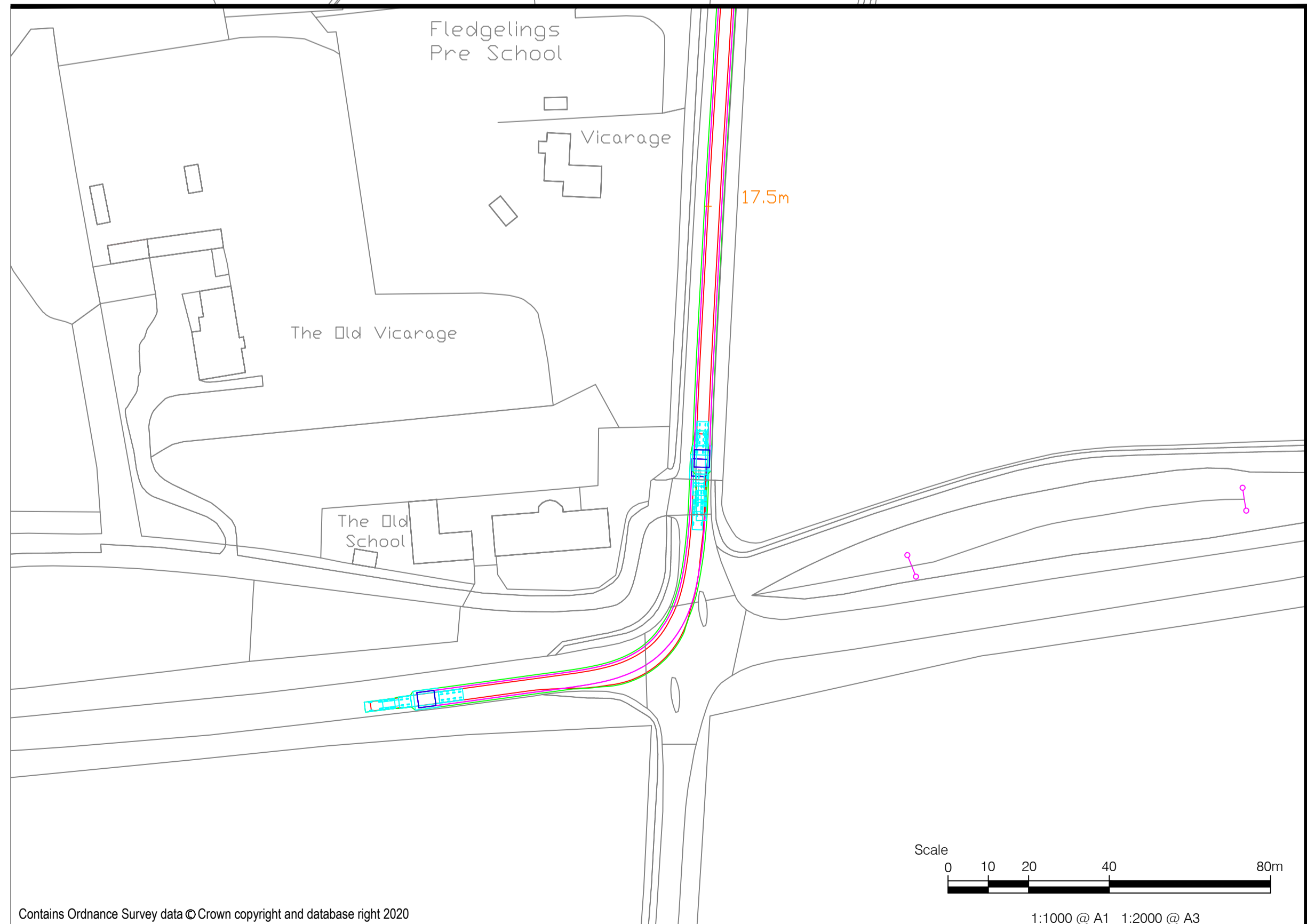
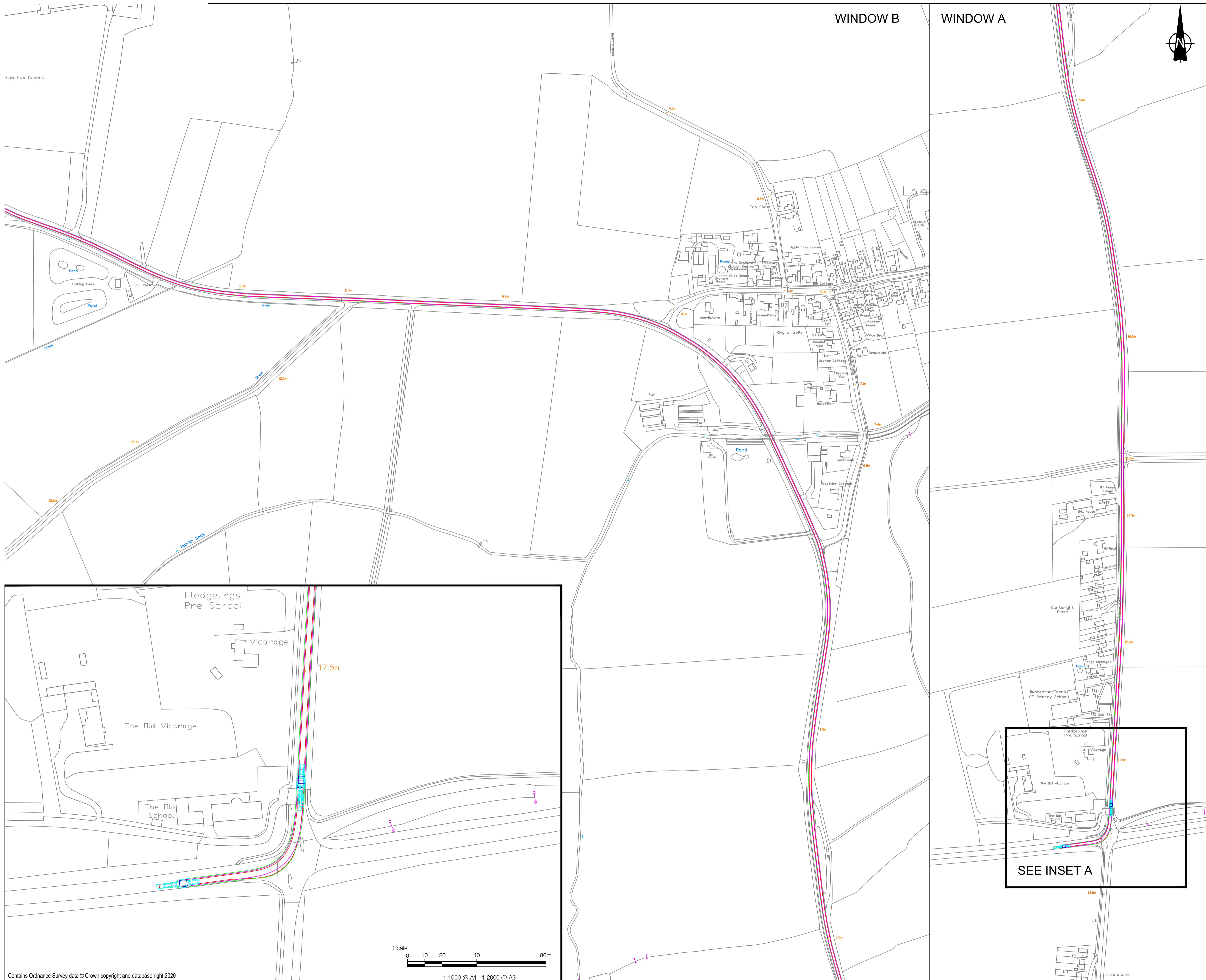

ISSUE/REVISION

I/R	DATE	DESCRIPTION

This drawing has been prepared for the use of AECOM's client. It may not be used, modified, reproduced or relied upon by third parties, except as agreed by AECOM or as required by law. AECOM accepts no responsibility, and denies any liability whatsoever, to any party that uses or relies on this drawing without AECOM's express written consent. Do not scale this document.

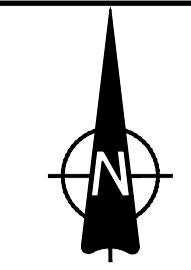

PROJECT
 Gate Burton Energy Park
 Development Consent Order

CLIENT
 Low Carbon

CONSULTANT
 AECOM
 Saxon House, 27 Duke Street
 Chelmsford, Essex, CM1 1HT
 01245 771200 tel 01245 476121 fax

GENERAL NOTES
INBOUND DELIVERY VEHICLE TRACKING

KEY

- Vehicle body
- Vehicle body path
- Vehicle load
- Vehicle load path
- Vehicle wheels path
- Edge of road

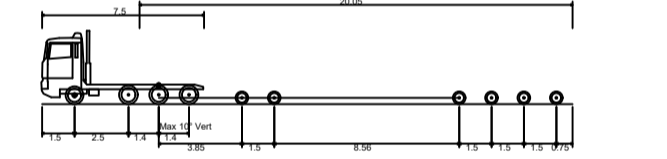
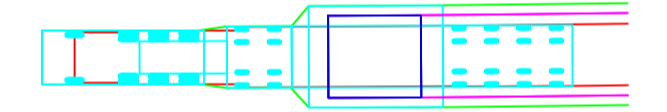

Transporter	24.560m
Overall Length	4.700m
Overall Width	3.368m
Overall Body Height	0.285m
Min Body Ground Clearance	2.479m
Max Track Width	6.00s
Lock to lock time	6.790m
Kerb to Kerb Turning Radius	

SHEET PLAN

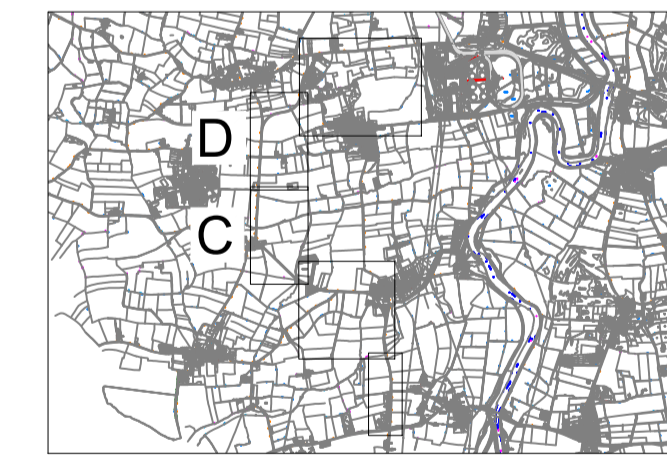

ISSUE/REVISION

I/R	DATE	DESCRIPTION

PROJECT NUMBER

60664324

SHEET TITLE

Swept Path Analysis - Cable Route AILs
 Route 2 - A57 Cottam Road
 Accesses O and P. Sheet 3 of 6

SHEET NUMBER

60664324-75-TRA-404

This drawing has been prepared for the use of AECOM's client. It may not be used, modified, reproduced or relied upon by third parties, except as agreed by AECOM or as required by law. AECOM accepts no responsibility, and denies any liability whatsoever, to any party that uses or relies on this drawing without AECOM's express written consent. Do not scale this document.

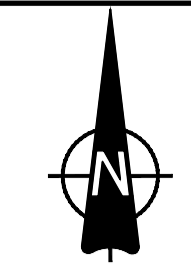

PROJECT
 Gate Burton Energy Park
 Development Consent Order

CLIENT
 Low Carbon

CONSULTANT
 AECOM
 Saxon House, 27 Duke Street
 Chelmsford, Essex, CM1 1HT
 01245 771200 tel 01245 476121 fax

GENERAL NOTES
OUTBOUND VEHICLE TRACKING

KEY

- Vehicle body
- Vehicle body path
- Vehicle load
- Vehicle load path
- Vehicle wheels path
- Edge of road

Transporter

Overall Length	24.560m
Overall Width	4.700m
Overall Body Height	3.368m
Min Body Ground Clearance	0.285m
Max Track Width	2.479m
Lock to lock time	6.00s
Kerb to Kerb Turning Radius	6.790m

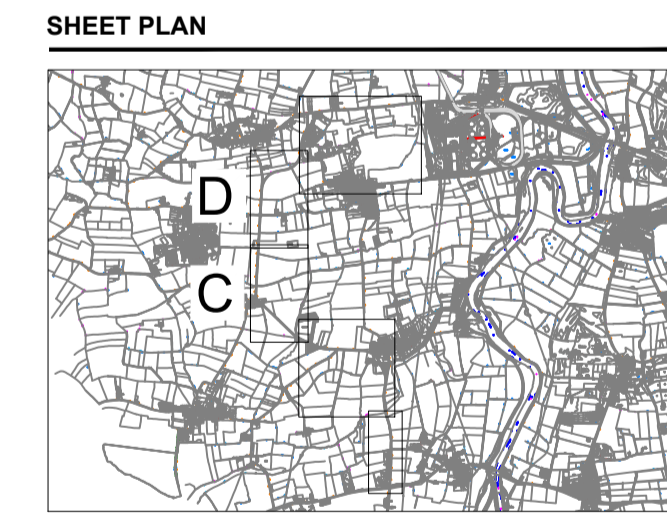

ISSUE/REVISION

I/R	DATE	DESCRIPTION

PROJECT NUMBER
 60664324

SHEET TITLE
 Swept Path Analysis - Cable Route ALLs
 Route 2 - A57 Cottam Road
 Accesses O and P. Sheet 4 of 6

SHEET NUMBER
 60664324-75-TRA-405

This drawing has been prepared for the use of AECOM's client. It may not be used, modified, reproduced or relied upon by third parties, except as agreed by AECOM or as required by law. AECOM accepts no responsibility, and denies any liability whatsoever, to any party that uses or relies on this drawing without AECOM's express written consent. Do not scale this document.

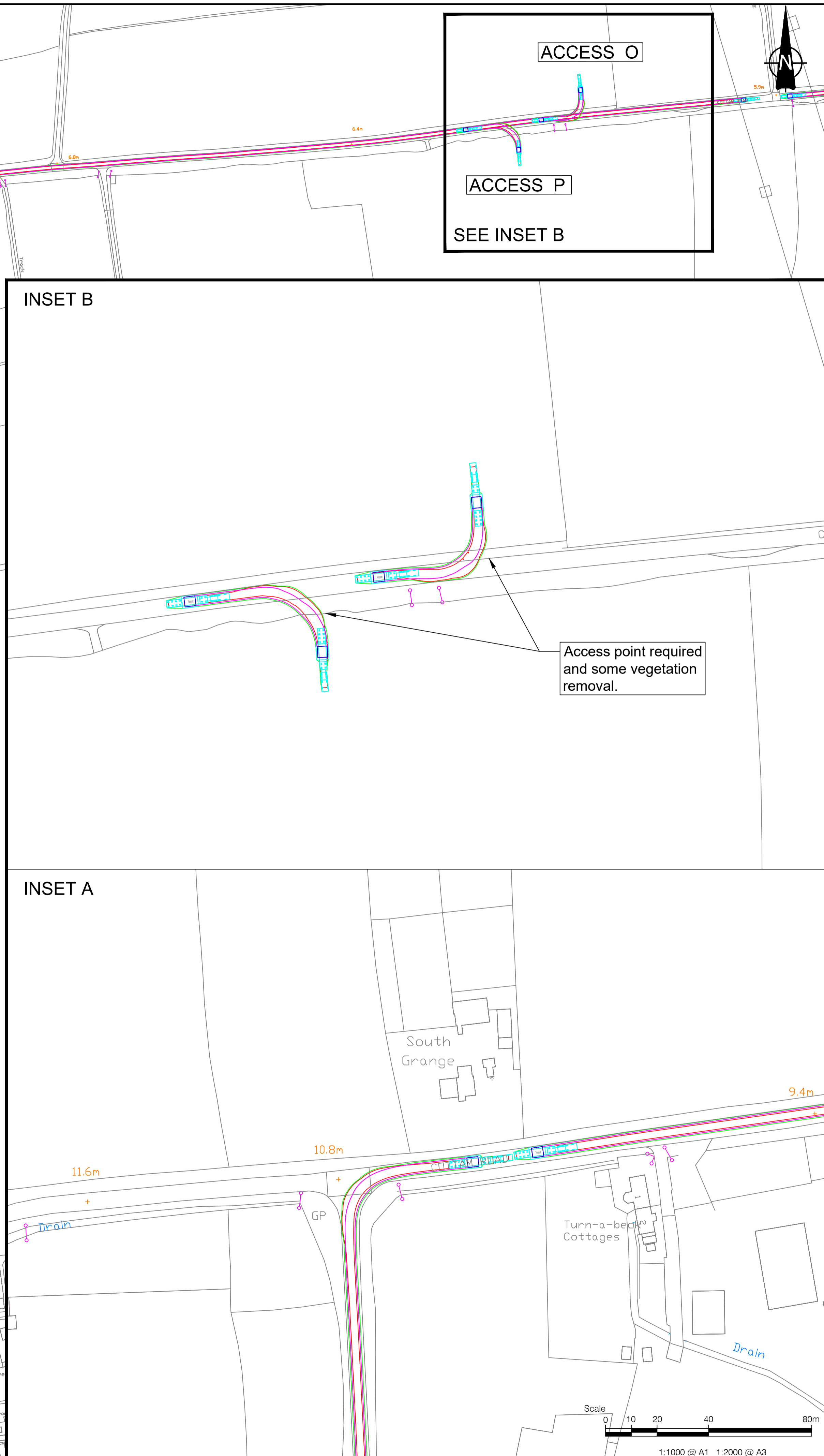
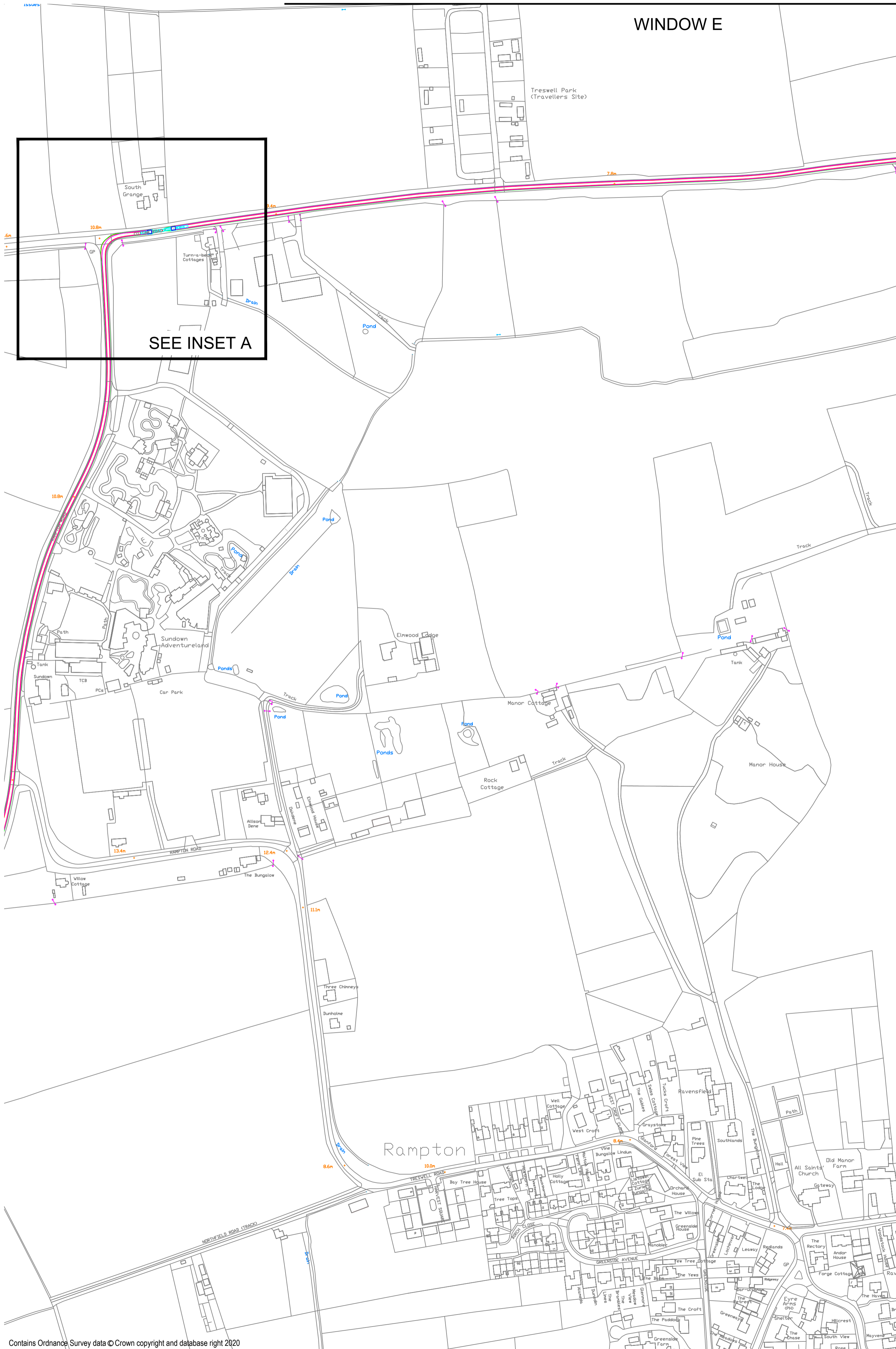

PROJECT
 Gate Burton Energy Park
 Development Consent Order

CLIENT
 Low Carbon

CONSULTANT
 AECOM
 Saxon House, 27 Duke Street
 Chelmsford, Essex, CM1 1HT
 01245 771200 tel 01245 476121 fax

GENERAL NOTES
INBOUND DELIVERY VEHICLE TRACKING

- KEY**
- Vehicle body
 - Vehicle body path
 - Vehicle load
 - Vehicle load path
 - Vehicle wheels path
 - Edge of road

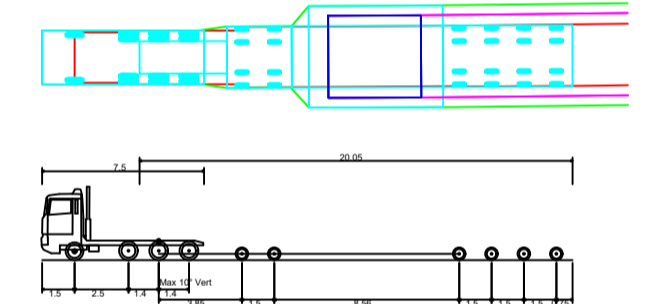

Transporter
 Overall Length 24.560m
 Overall Width 4.700m
 Overall Height 3.368m
 Min Body Ground Clearance 0.285m
 Max Track Width 2.479m
 Lock to lock time 6.00s
 Kerb to Kerb Turning Radius 6.790m

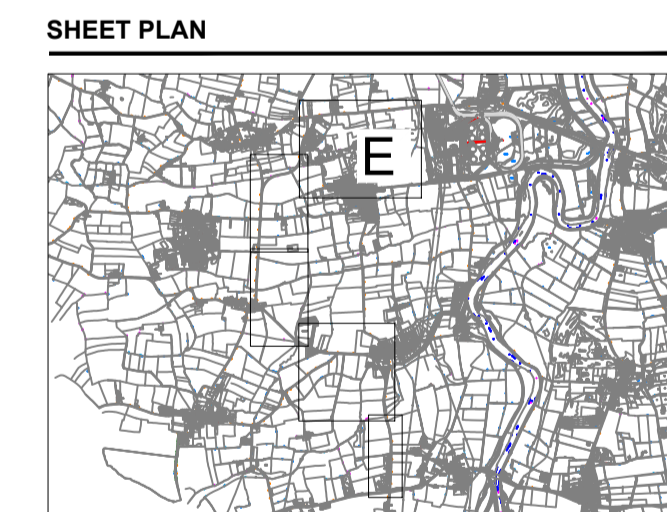

ISSUE/REVISION

I/R	DATE	DESCRIPTION

PROJECT NUMBER
 60664324

SHEET TITLE
 Swept Path Analysis - Cable Route AILs
 Route 2 - A57 Cottam Road
 Accesses O and P. Sheet 5 of 6

SHEET NUMBER
 60664324-75-TRA-406

This drawing has been prepared for the use of AECOM's client. It may not be used, modified, reproduced or relied upon by third parties, except as agreed by AECOM or as required by law. AECOM accepts no responsibility, and denies any liability whatsoever, to any party that uses or relies on this drawing without AECOM's express written consent. Do not scale this document.

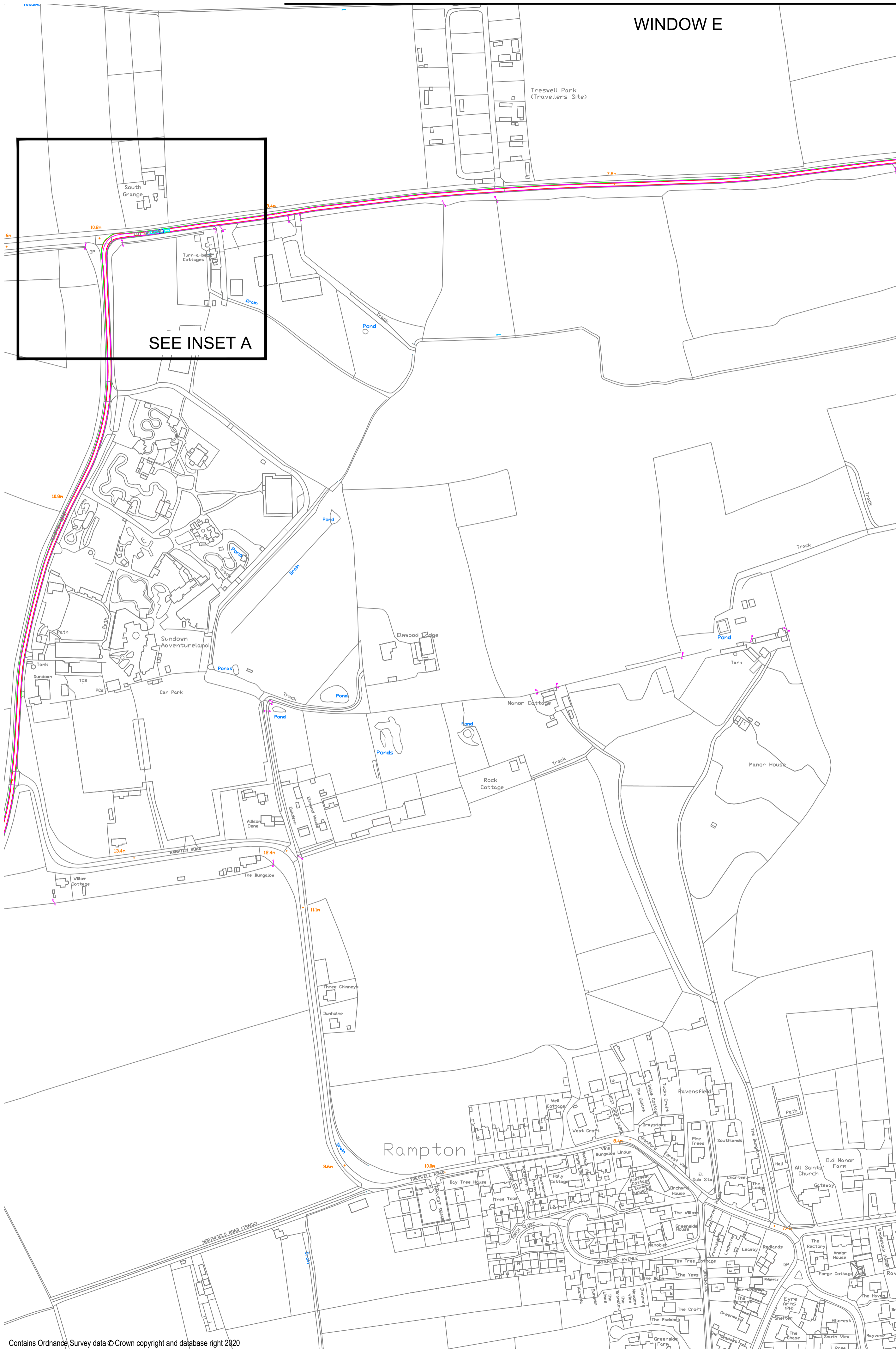

WINDOW E

SEE INSET A

ACCESS O
 ACCESS P
 SEE INSET B

INSET B

INSET A

Access point required and some vegetation removal.

PROJECT
 Gate Burton Energy Park
 Development Consent Order

CLIENT
 Low Carbon

CONSULTANT
 AECOM
 Saxon House, 27 Duke Street
 Chelmsford, Essex, CM1 1HT
 01245 771200 tel 01245 476121 fax

GENERAL NOTES
 OUTBOUND VEHICLE TRACKING

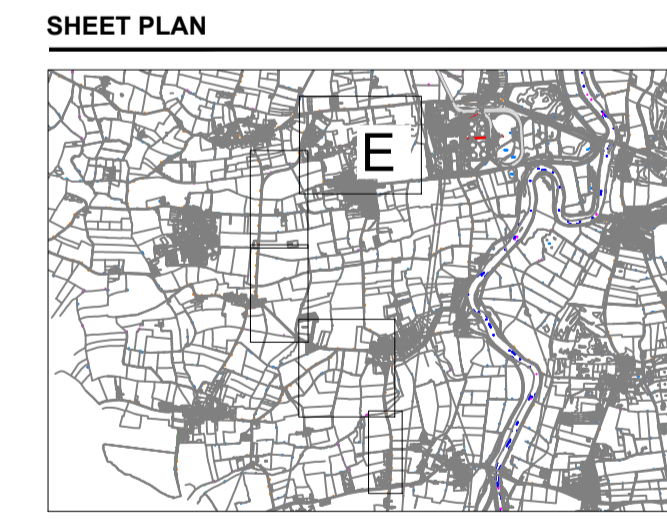
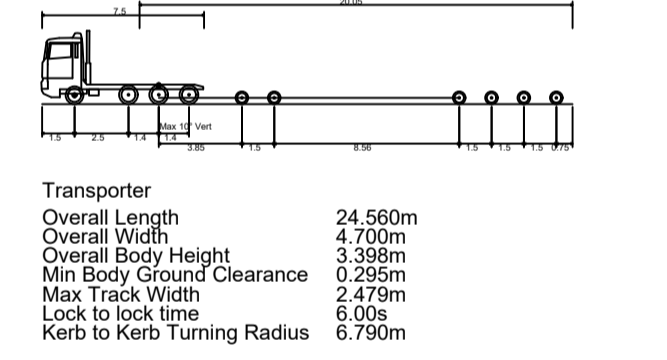
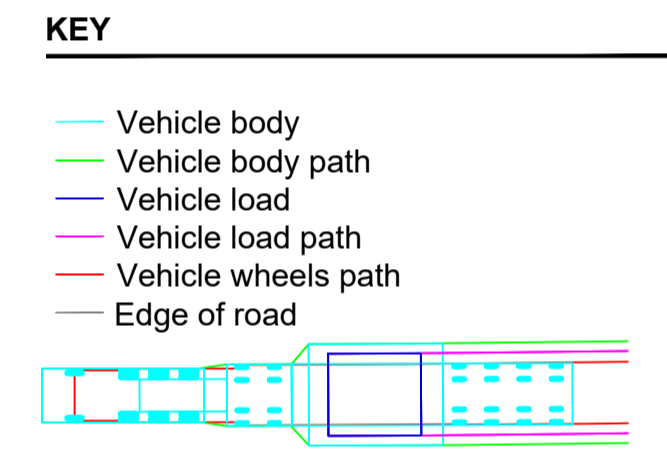

ISSUE/REVISION

I/R	DATE	DESCRIPTION

PROJECT NUMBER
 60664324

SHEET TITLE
 Swept Path Analysis - Cable Route AILs
 Route 2 - A57 Cottam Road
 Accesses O and P. Sheet 6 of 6

SHEET NUMBER
 60664324-75-TRA-407

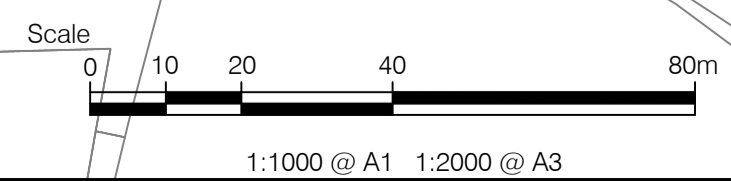

This drawing has been prepared for the use of AECOM's client. It may not be used, modified, reproduced or relied upon by third parties, except as agreed by AECOM or as required by law. AECOM accepts no responsibility, and denies any liability whatsoever, to any party that uses or relies on this drawing without AECOM's express written consent. Do not scale this document.

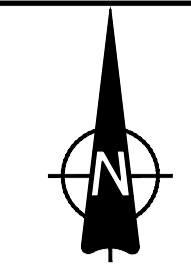
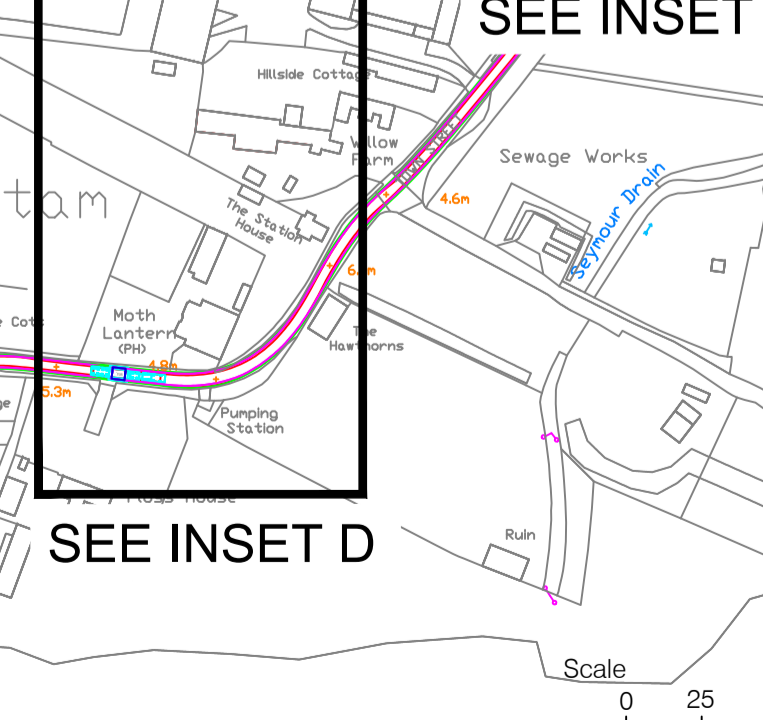
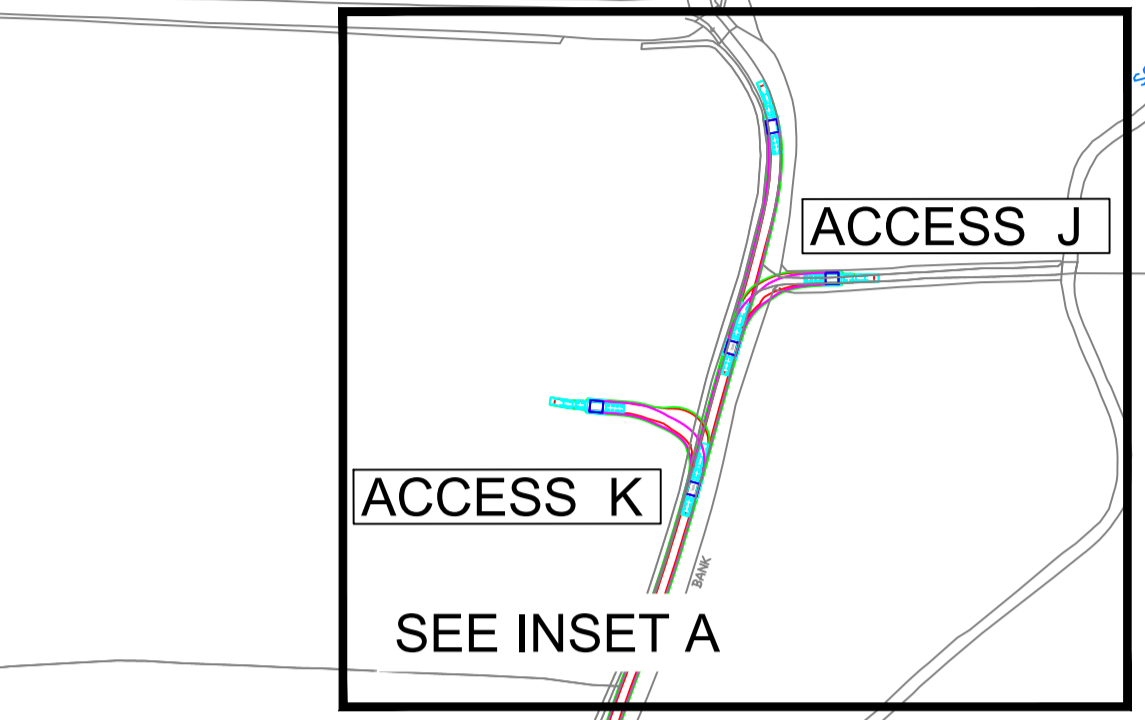
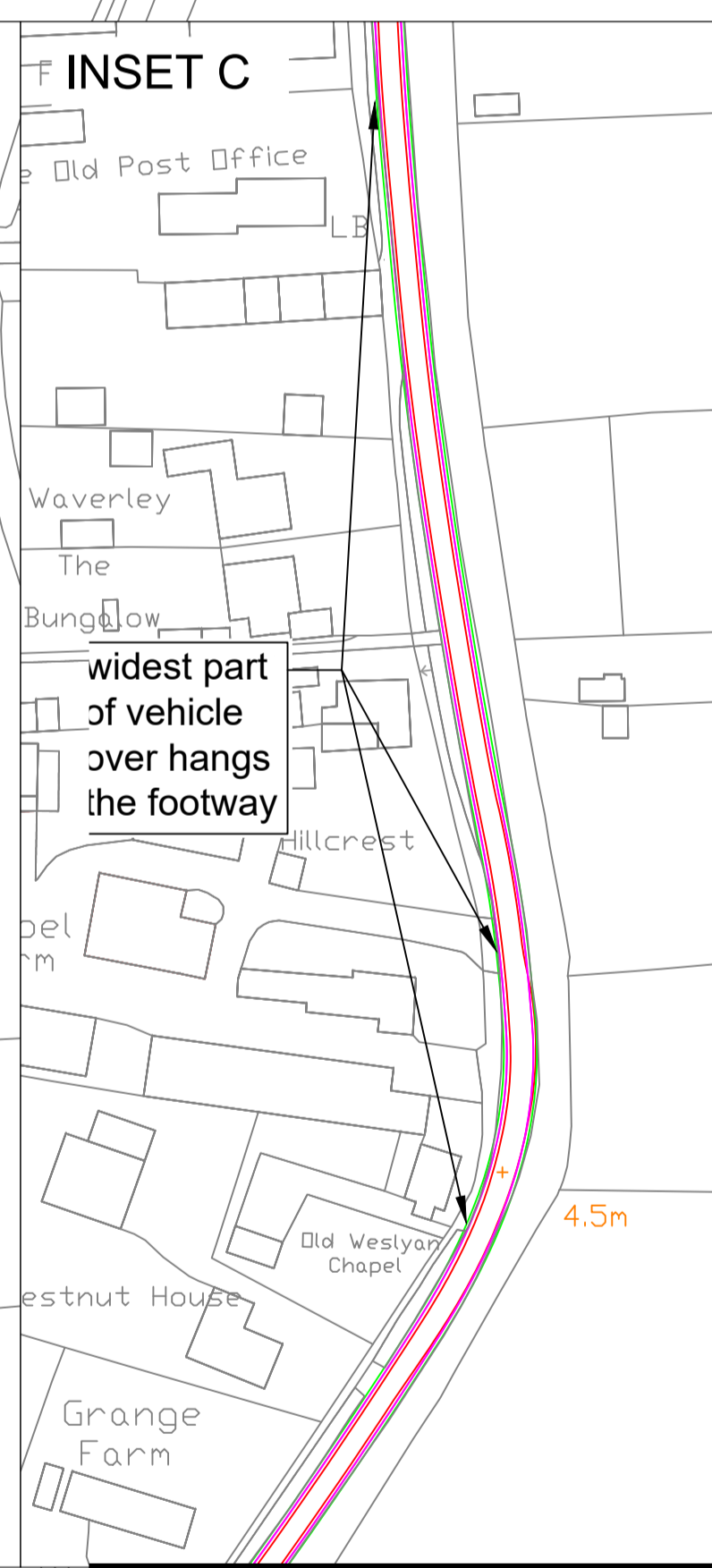
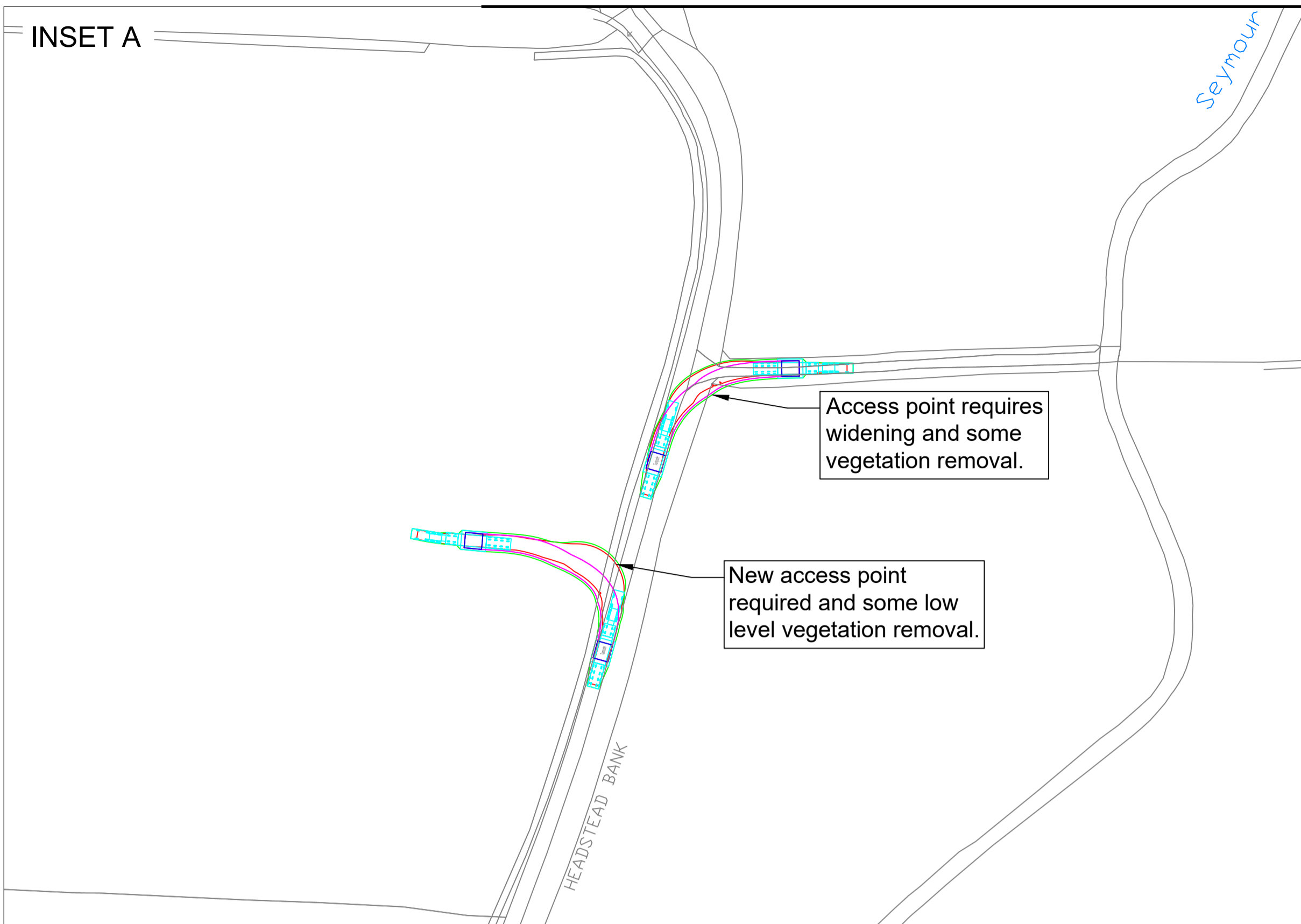
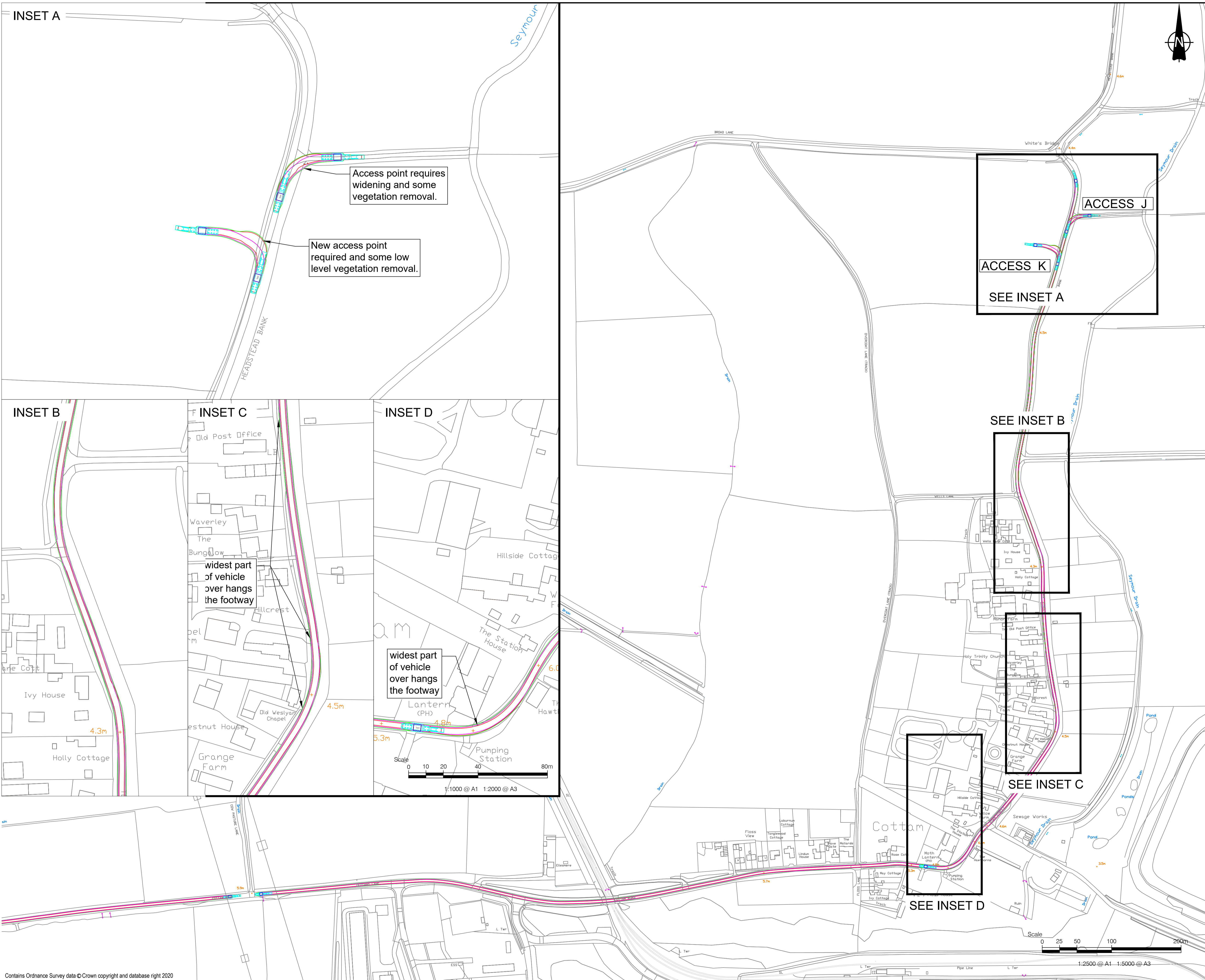

PROJECT
 Gate Burton Energy Park
 Development Consent Order

CLIENT
 Low Carbon

CONSULTANT
 AECOM
 Saxon House, 27 Duke Street
 Chelmsford, Essex, CM1 1HT
 01245 771200 tel 01245 476121 fax

GENERAL NOTES
INBOUND DELIVERY VEHICLE TRACKING

KEY

- Vehicle body
- Vehicle body path
- Vehicle load
- Vehicle load path
- Vehicle wheels path
- Edge of road

Transporter

Overall Length	24.560m
Overall Width	4.700m
Overall Height	3.360m
Min Body Ground Clearance	0.285m
Max Track Width	2.479m
Lock to lock time	6.00s
Kerb to Kerb Turning Radius	6.790m

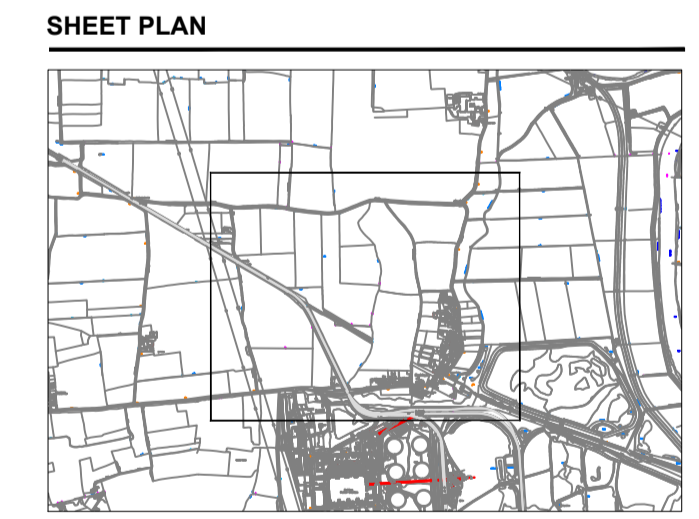

ISSUE/REVISION

I/R	DATE	DESCRIPTION

PROJECT NUMBER
 60664324

SHEET TITLE
 Swept Path Analysis - Cable Route AILs
 Route 3 - Cottam Road to Headstead Bank
 Accesses J and K. Sheet 1 of 2

SHEET NUMBER
 60664324-75-TRA-408

This drawing has been prepared for the use of AECOM's client. It may not be used, modified, reproduced or relied upon by third parties, except as agreed by AECOM or as required by law. AECOM accepts no responsibility, and denies any liability whatsoever, to any party that uses or relies on this drawing without AECOM's express written consent. Do not scale this document.

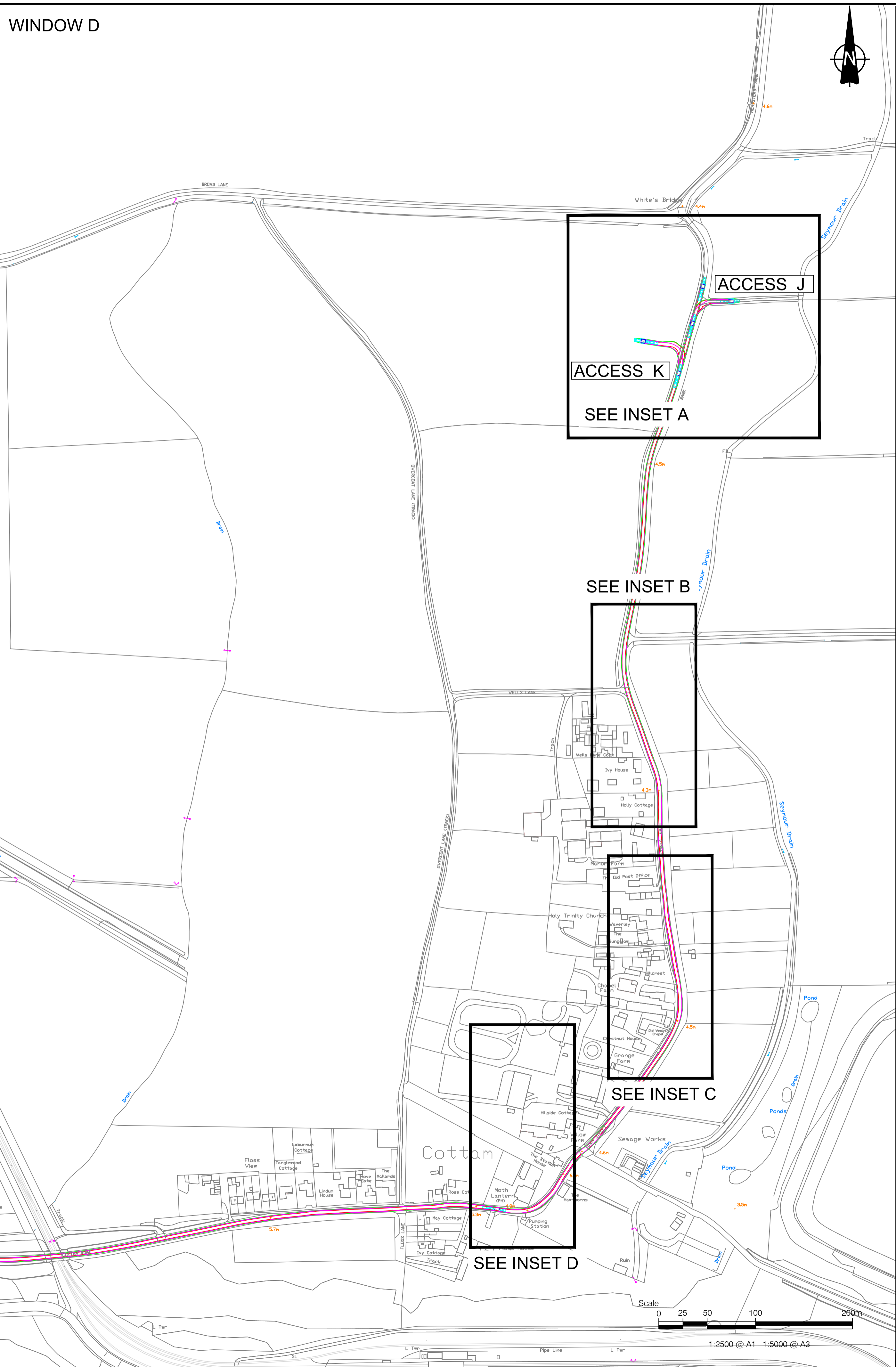
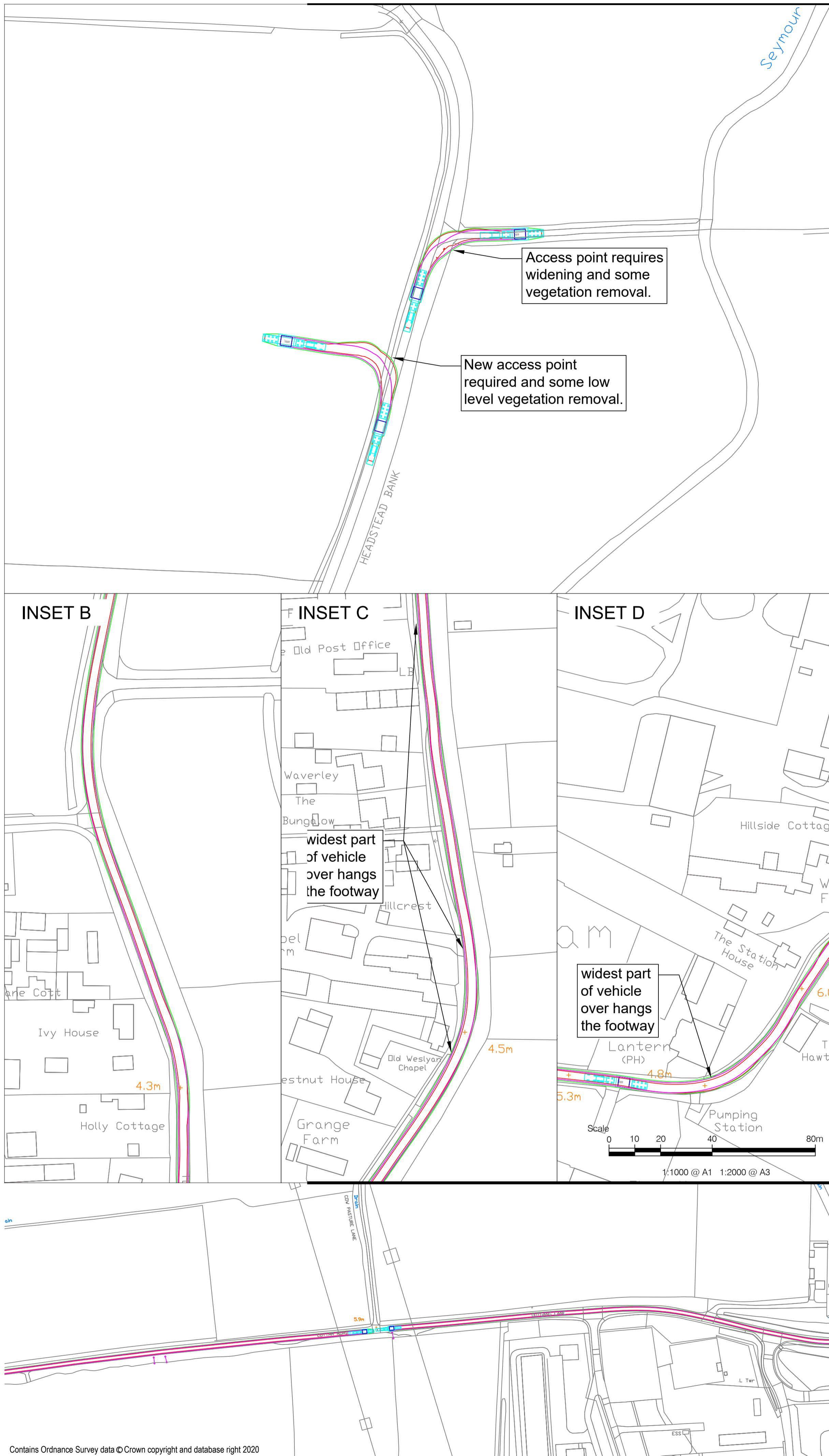

PROJECT
 Gate Burton Energy Park
 Development Consent Order

CLIENT
 Low Carbon

CONSULTANT
 AECOM
 Saxon House, 27 Duke Street
 Chelmsford, Essex, CM1 1HT
 01245 771200 tel 01245 476121 fax

GENERAL NOTES
 OUTBOUND DELIVER VEHICLE TRACKING

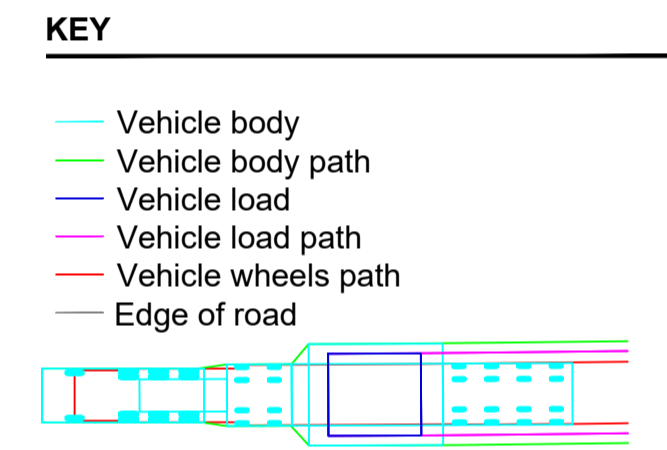

Transporter

Overall Length	24.560m
Overall Width	4.700m
Overall Body Height	3.368m
Min Body Ground Clearance	0.285m
Max Track Width	2.479m
Lock to lock time	6.00s
Kerb to Kerb Turning Radius	6.790m

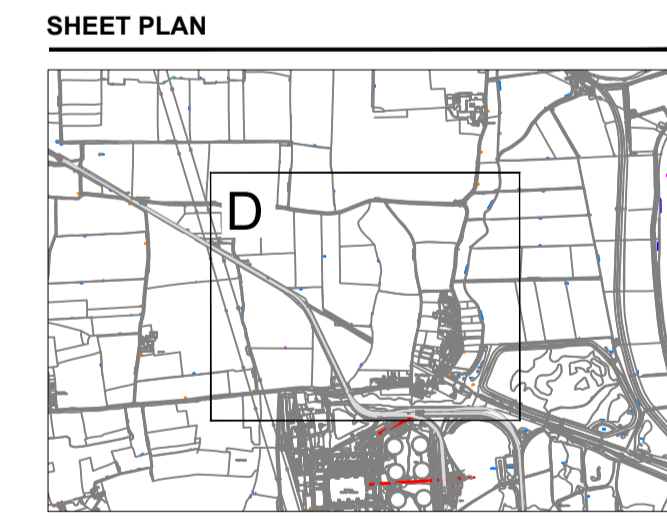

ISSUE/REVISION

I/R	DATE	DESCRIPTION

PROJECT NUMBER
 60664324

SHEET TITLE
 Swept Path Analysis - Cable Route AILs
 Route 3 - Cottam Road to Headstead Bank
 Accesses J and K. Sheet 2 of 2

SHEET NUMBER
 60664324-75-TRA-409

This drawing has been prepared for the use of AECOM's client. It may not be used, modified, reproduced or relied upon by third parties, except as agreed by AECOM or as required by law. AECOM accepts no responsibility, and denies any liability whatsoever, to any party that uses or relies on this drawing without AECOM's express written consent. Do not scale this document.

Annex D. Abnormal Vehicles Route Access Survey (Solar and Energy Storage Park)

COLLETT

EXPERTS IN MOTION



Route Access Survey
373778

Gate Burton Energy Park

Low Carbon
June 2022

COLLETT
EXPERTS IN MOTION

Victoria Terminal
Albert Road
HALIFAX
West Yorkshire
HX2 0DF

Mistral Point
AW Nielsen Road
GOOLE
East Yorkshire
DN14 6UE

Baltic House
Central Dock Road
GRANGEMOUTH
Central Scotland
FK3 8TY

Tel. +44 (0) 8456 255 233
Fax +44 (0) 8456 255 244
Email info@collett.co.uk

Contents

REPORT DETAILS..... 3

1. EXECUTIVE SUMMARY 5

2. INTRODUCTION..... 6

3. CANDIDATE ABNORMAL LOADS..... 6

4. ABNORMAL INDIVISIBLE LOAD PROFILES 6

5. ROUTE ASSESSMENT OVERVIEW 7

6. IMPORTANT NOTES 24

APPENDIX 1 – LOADED CONFIGURATION DRAWINGS

APPENDIX 2 – SWEEP PATH ANALYSIS

Report Details

Report for
Low Carbon

Attendees of Survey
Jason Wain

Time / Date of Survey: 17th June 2022

General weather conditions: Dry & Sunny

Issued by
Jason Wain

Approved by
Eric Crosby

Collett & Sons Ltd
Mistral Point
A.W Nielsen Road
Goole
East Yorkshire
DN14 6UE
Tel: +44 (0)8456 255233

Document Revisions

No	Date	Details
00	27/06/2022	First issue.

Non-Disclosure Notice

The methodology contained in this report is provided to you in confidence and must not be disclosed or copied to third parties without the prior written agreement of Collett & Sons Limited. Disclosure of that information may constitute an actionable breach of confidence or may otherwise prejudice our commercial interests. Any third party who obtains access to this report by any means will, in any event, be subject to the Third-Party Disclaimer set out below.

Third Party Disclaimer

Any disclosure of this report to a third party is subject to this disclaimer. The report was prepared by Collett & Sons Limited at the instruction of, and for use by, our client named on the front of the report. It does not in any way constitute advice to any third party who is able to access it by any means. Collett & Sons Limited excludes to the fullest extent lawfully permitted all liability whatsoever for any loss or damage howsoever arising from reliance on the contents of this report. We do not however exclude our liability (if any) for personal injury or death resulting from our negligence, for fraud or any other matter in relation to which we cannot legally exclude liability.

Company Profile

Collett & Sons Ltd established in Halifax over 45 years ago specialise in the multimodal logistics throughout the UK, Europe and Worldwide.

Our Company owns a modern fleet of over 60 vehicles and over 100 trailers, operating from 3 depots located in Halifax, Goole and Grangemouth.

The depots situated in Goole and Grangemouth offer strategically located sites suitable to provide central hubs for distribution throughout the UK. Each facility is complete with up to 110 tonnes lifting capacity in order to be able to handle all various abnormal load types. As logistical partners, the company is able to offer the complete transport solution from point of manufacture through to job site.

Collett & Sons Limited operate an in-house consultancy that deals with transport feasibility, route and site access surveys, Swept Path Analysis, Traffic Management Plans, Test Drives and Environment Statements.

In addition to consulting services, Collett & Sons Limited delivers the following services;

- Marine
- Port Operation
- Heavy Lift Storage
- Heavy Transport
- Project Management
- Freight Forwarding
- Heavy Lift
- General Haulage Cape
- Warehousing
- Test Station (DVSA-authorized)
- SHEQ Training



Collett & Sons Ltd
Victoria Terminal
Albert Road
Halifax
West Yorkshire
HX2 0DF

+44 (0)8456 255233
projects@collett.co.uk

1. Executive Summary

- 1.1. This report comprises of a study of the road route as detailed here in for the road transport of a transformer in a Girder Bridge configuration to the proposed Gate Burton Energy Park.
- 1.2. Routes have been assessed from Immingham Port to the proposed site access location.
- 1.3. Further investigation is required to confirm route negotiability. Vertical assessment required at item 5.9.1.

Third party land

- 1.4. Third-party land required to create an access point 1 off A156.

Road widening

- 1.5. Road widening required at access point 1 off the A156.

Modifications to street furniture

- 1.6. Modifications where necessary are detailed in the report.

Vertical Alignment and Height Clearances

- 1.7. There is a vertical alignment issue identified on the route at Marton on A1500.
- 1.8. Height restriction has been identified on alternative route from the North at Gainsborough on A156 Lea Road at 4.2m high.
- 1.9. There is a vertical alignment issue identified on alternative route from the South at Torksey Lock on A156 over Foss Dyke.

Structural Assessment

- 1.10. No structural assessment has been undertaken as part of the survey. It is possible that full structural surveys may be required along the route and will be identified during the permitting process.

Other areas of note

- 1.11. Routes from the North and South Were also checked. The route from the North has a low bridge marked at 4.2m height clearance and is not suitable for this vehicle. The route from the South is a longer route and has a hump back bridge which would require further investigation to clarify if the vehicle can negotiate this. As detailed in item 1.8 & 1.9 above.

2. Introduction

- 2.1 Collett & Sons Ltd. were commissioned by Low Carbon to undertake an abnormal load route access study to assess the transportation of 1 transformer to the proposed Gate Burton Energy Park near Gainsborough.
- 2.2 The road routes as detailed herein are for the road transport of the transformer transport configuration identified in Section 4.
- 2.3 The purpose of this report is to detail access to the site.

3. Candidate Abnormal Loads

- 3.1. Low Carbon have requested that the assessment on which this report is compiled be based on the following Cargo Details:

Transformer: 7.8m L x 3.6m W x 4.4m H – Weight c. 210Te.

4. Abnormal Indivisible Load Profiles

- 4.1. The abnormal load components are assessed based on weight, length, width and height and loaded to the most appropriate vehicle the weights and dimensions of these are detailed below. The loading diagrams are detailed in Appendix 1.

4.2.	COL-D-373778-1-1
Transformer in Girder Bridge	
	Loaded vehicle dimensions
Overall vehicle Length	65.813m
Rigid Length	41.680m
Width	5.05m
Height	4.715m
Gross Vehicle Weight Exc. Tractor Units	333.912Te
Maximum axle weight	16.696Te

5. Route Assessment Overview

- 5.1. This section of the report illustrates the route assessed for the delivery of a transformer from Immingham Port to Gate Burton Energy Park.
- 5.2. For the purpose of this report, one route to the site was surveyed. All the routes surveyed in this report have been identified by Collett.

Route A

Start Location	Immingham Port	Distance of Route	Km	Miles
Via:	A160,A180,A15,A1500,A156		70.5	43.8
<ul style="list-style-type: none"> • Exit Immingham Port via Humber Road (West Gate) • At Roundabout turn right A160 • At Roundabout turn right A180 • Turn left A15 • Turn right A1500 Till Bridge Lane • Turn right A156 Gainsborough Road • Turn right into proposed site Access Point 1. Approx. OS Grid Ref: SK 83040 84091 				

5.3. Map Overview

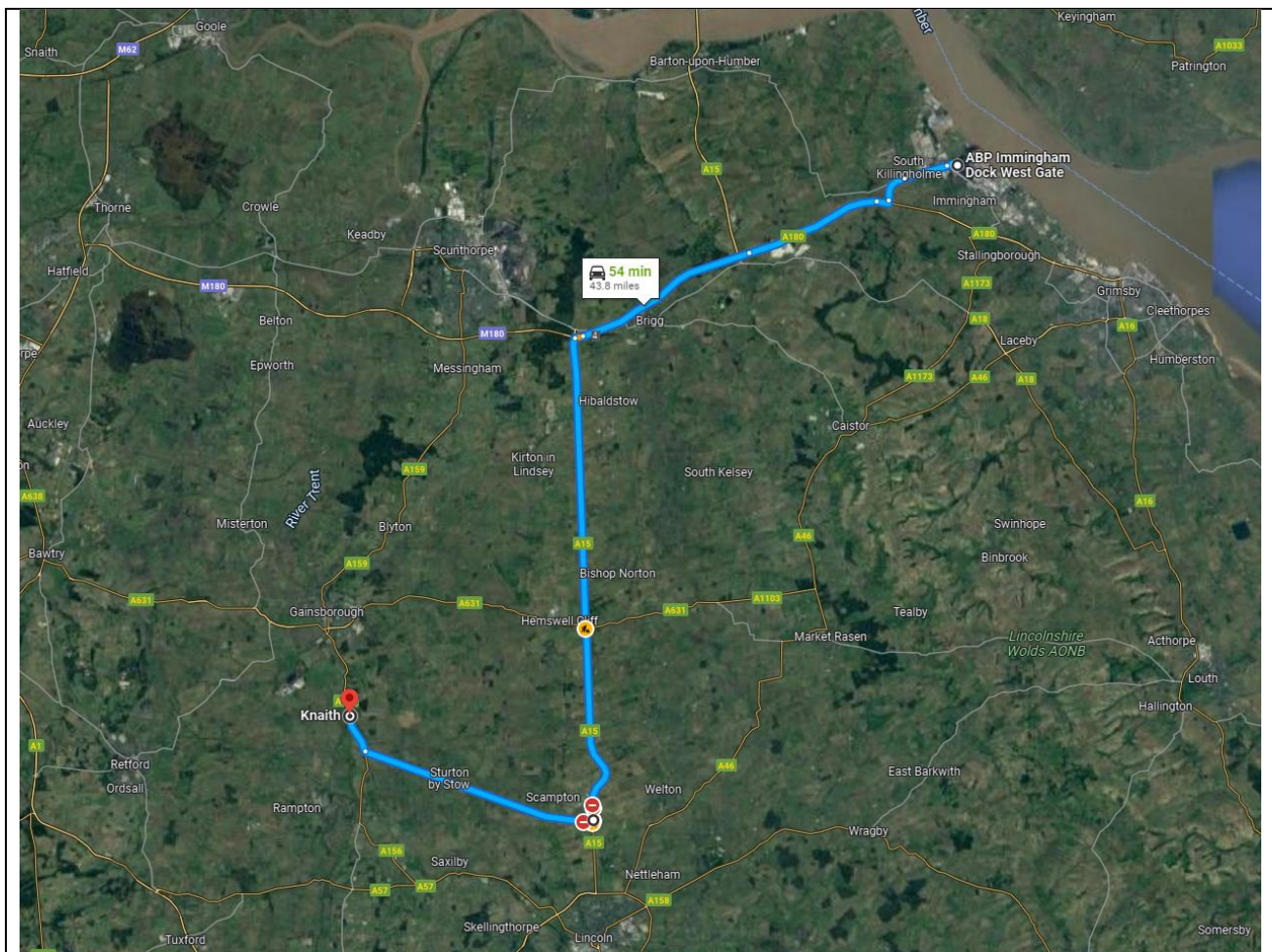

5.4. Amendment Categorisation

For the purposes of this report, the route amendments have been identified into 3 categories.

Major Amendments – Third Party Land, Road Widening

Minor Amendments – Modifications to Street Furniture, Tree Pruning, Contraflow Manoeuvre

No Amendments – Location is suitable as assessed during this survey



The categories have been colour coded for each report item as per the below key.



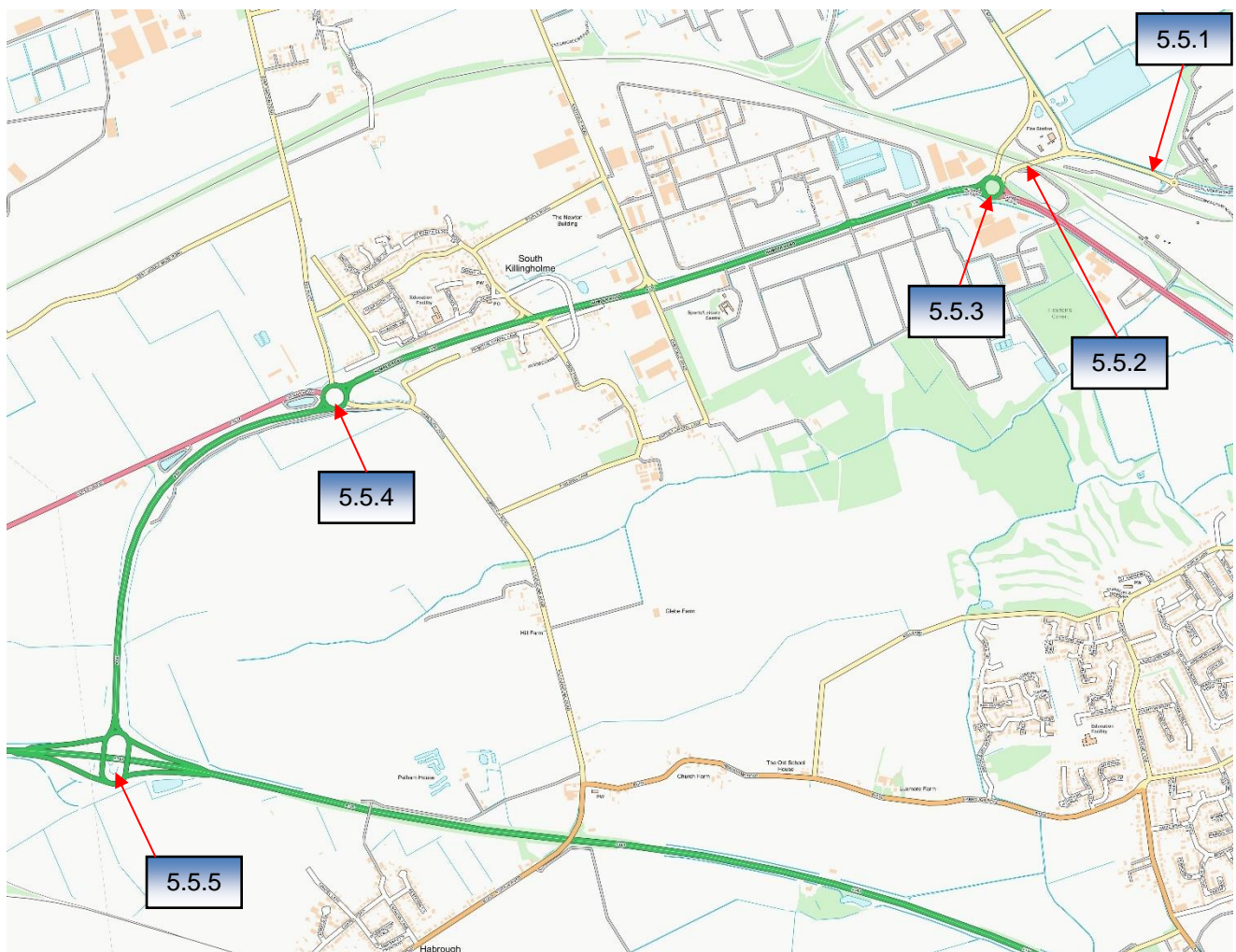

KEY			
	Major Amendments		Minor Amendments
	No Amendments		

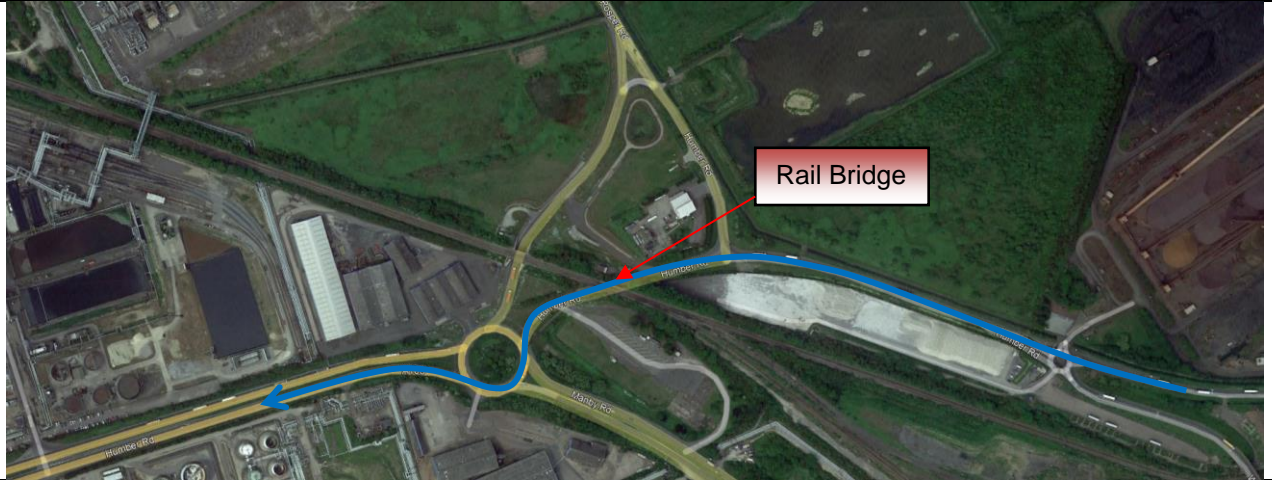

5.5. Map extract of survey locations



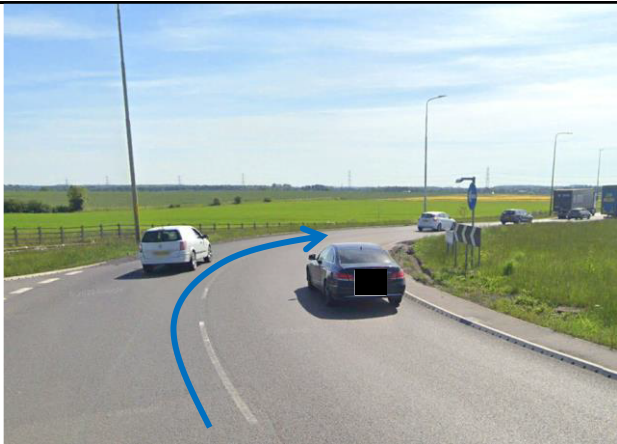

ITEM NUMBER	5.5.1		LOCATION	Immingham Port – West Gate	
DIRECTION	Contraflow past the security Cabin at West Gate.				
GRID REFERENCE	TA 17676 16624				
MODIFICATION AND DESCRIPTION			PHOTOGRAPH OF LOCATION		
<p>The Abnormal load vehicle will exit Immingham Port via the Abnormal Load Gate at the West Gate Entrance. A contraflow manoeuvre is required to utilise this gate. The gate should be opened to maximise the width available.</p>					
			<p>Abnormal Load Gate</p> 		
			<p>View After Gate</p> 		
Aerial View of Location					
FURTHER INVESTIGATION UNDERTAKEN?		NO	TYPE	N/A	
RELATED DOCUMENT NUMBERS		N/A			

ITEM NUMBER	5.5.2		LOCATION	Humber Road – Rail Bridge	
DIRECTION	Continue Humber Road under Rail Bridge				
GRID REFERENCE	TA 17140 16684				
MODIFICATION AND DESCRIPTION			PHOTOGRAPH OF LOCATION		
<p>Visual inspection indicates that the loaded vehicle will navigate under this bridge without any issues.</p> <p>The bridge was measured at 5.1m high at its lowest point.</p> <p>Note that the bridge is not marked with an official height notice and therefore tells us this bridge is 5m or above.</p>					
			View on approach to Bridge		
					
			View under Bridge		
					
Aerial View of Location					
FURTHER INVESTIGATION UNDERTAKEN?			NO	TYPE	N/A
RELATED DOCUMENT NUMBERS			N/A		

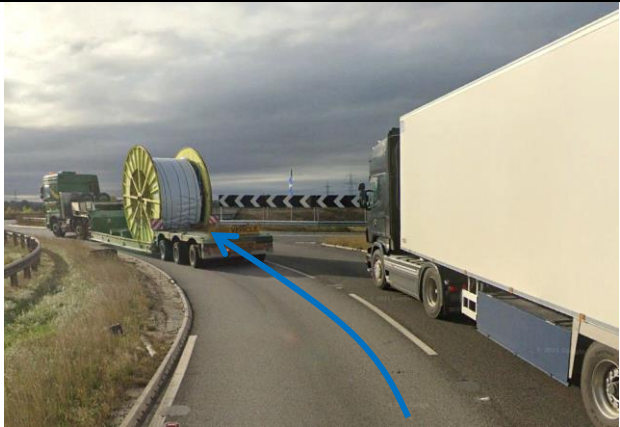
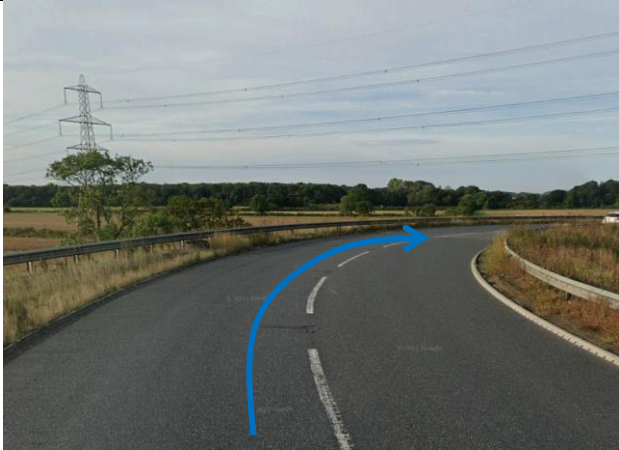

ITEM NUMBER	5.5.3		LOCATION	Humber Road / Manby Roundabout	
DIRECTION	At Roundabout turn right 3 rd exit.				
GRID REFERENCE	TA 17016 16612				
MODIFICATION AND DESCRIPTION			PHOTOGRAPH OF LOCATION		
<p>Visual inspection and Swept Path Analysis indicates that the loaded vehicle will navigate this roundabout without any issues.</p>					
			View on approach to roundabout		
					
View on roundabout			View of exit from roundabout		
					
Aerial View of Location					
FURTHER INVESTIGATION UNDERTAKEN?			YES	TYPE	Swept Path Analysis
RELATED DOCUMENT NUMBERS			COL-D-373778-10-1		

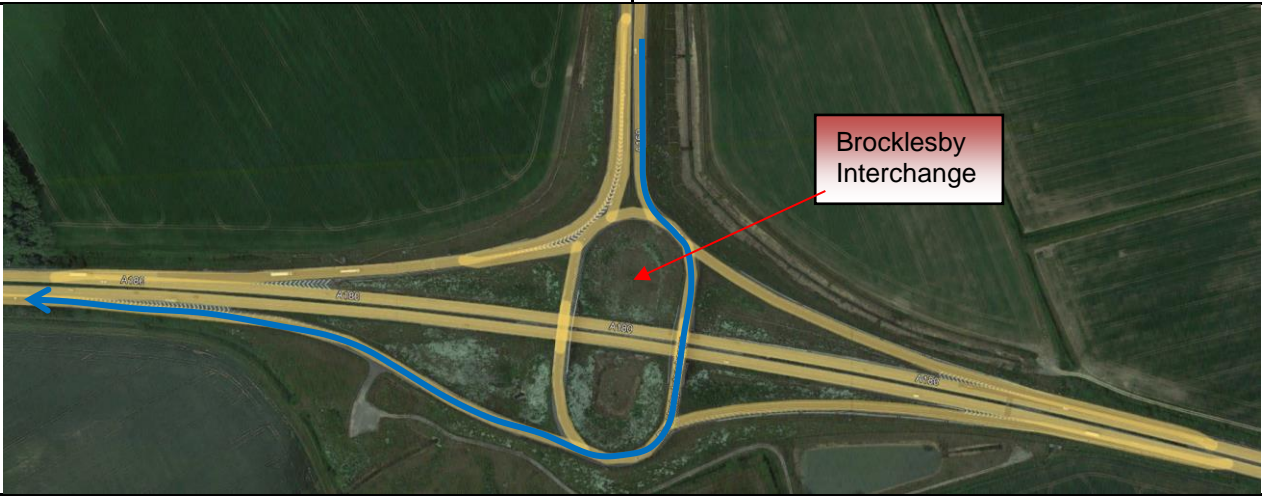
ITEM NUMBER	5.5.4	LOCATION	Humber Road / Habrough Roundabout
DIRECTION	At Roundabout take 2 nd exit.		
GRID REFERENCE	TA 14526 15798		
MODIFICATION AND DESCRIPTION		PHOTOGRAPH OF LOCATION	
<p>Visual inspection and Swept Path Analysis indicates that the loaded vehicle will navigate this roundabout without any issues.</p>			
		View on approach to roundabout	
			
View on roundabout		View of exit from roundabout	
			
Aerial View of Location			
FURTHER INVESTIGATION UNDERTAKEN?	YES	TYPE	Swept Path Analysis
RELATED DOCUMENT NUMBERS	COL-D-373778-10-2		

ITEM NUMBER	5.5.5		LOCATION	A180 Brocklesby Interchange	
DIRECTION	At Roundabout turn right 2 nd exit onto A180				
GRID REFERENCE	TA 13691 14485				
MODIFICATION AND DESCRIPTION			PHOTOGRAPH OF LOCATION		
<p>Visual inspection and Swept Path Analysis indicates that the loaded vehicle will navigate this roundabout without any issues.</p>					
			View on approach to roundabout		
					
View on roundabout			View of exit from roundabout		
					
Aerial View of Location					
FURTHER INVESTIGATION UNDERTAKEN?			YES	TYPE	Swept Path Analysis
RELATED DOCUMENT NUMBERS			COL-D-373778-10-3		

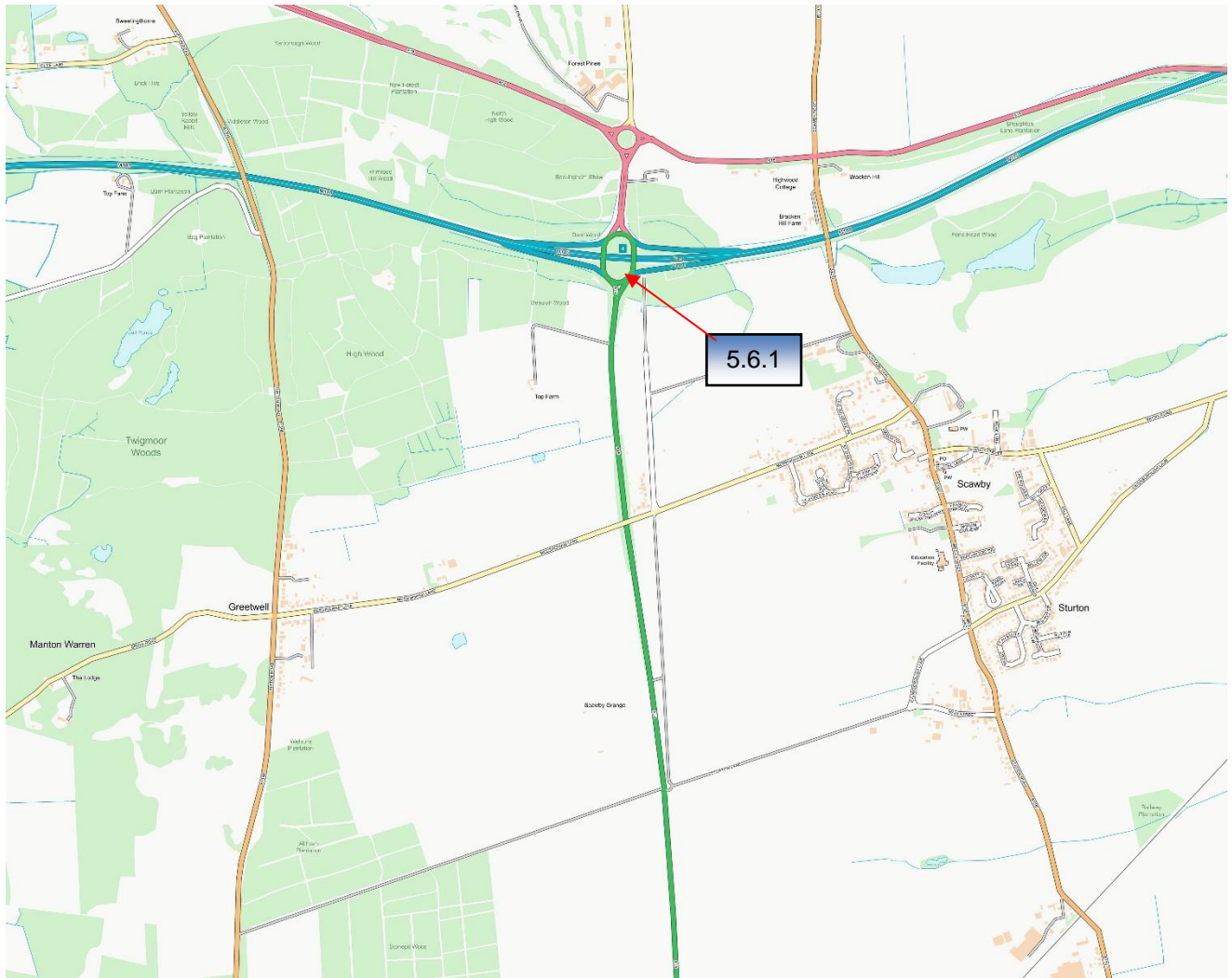

5.6. Map extract of survey locations

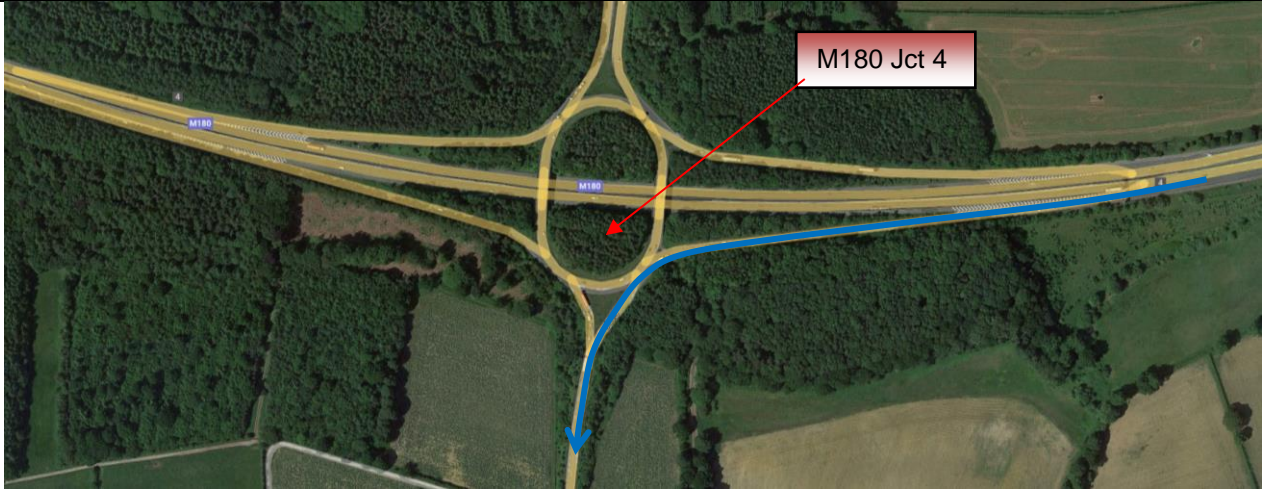

ITEM NUMBER	5.6.1		LOCATION	M180 / A15 Interchange	
DIRECTION	Exit M180 Jct 4 and at Roundabout turn left 1 st exit onto A15				
GRID REFERENCE	SE 95646 06235				
MODIFICATION AND DESCRIPTION			PHOTOGRAPH OF LOCATION		
<p>Visual inspection and Swept Path Analysis indicates that the loaded vehicle will navigate this roundabout without any issues.</p>					
			View on approach to Jct 4		
					
View on roundabout			View of exit from roundabout		
					
Aerial View of Location					
FURTHER INVESTIGATION UNDERTAKEN?		YES	TYPE	Swept Path Analysis	
RELATED DOCUMENT NUMBERS		COL-D-373778-10-4			

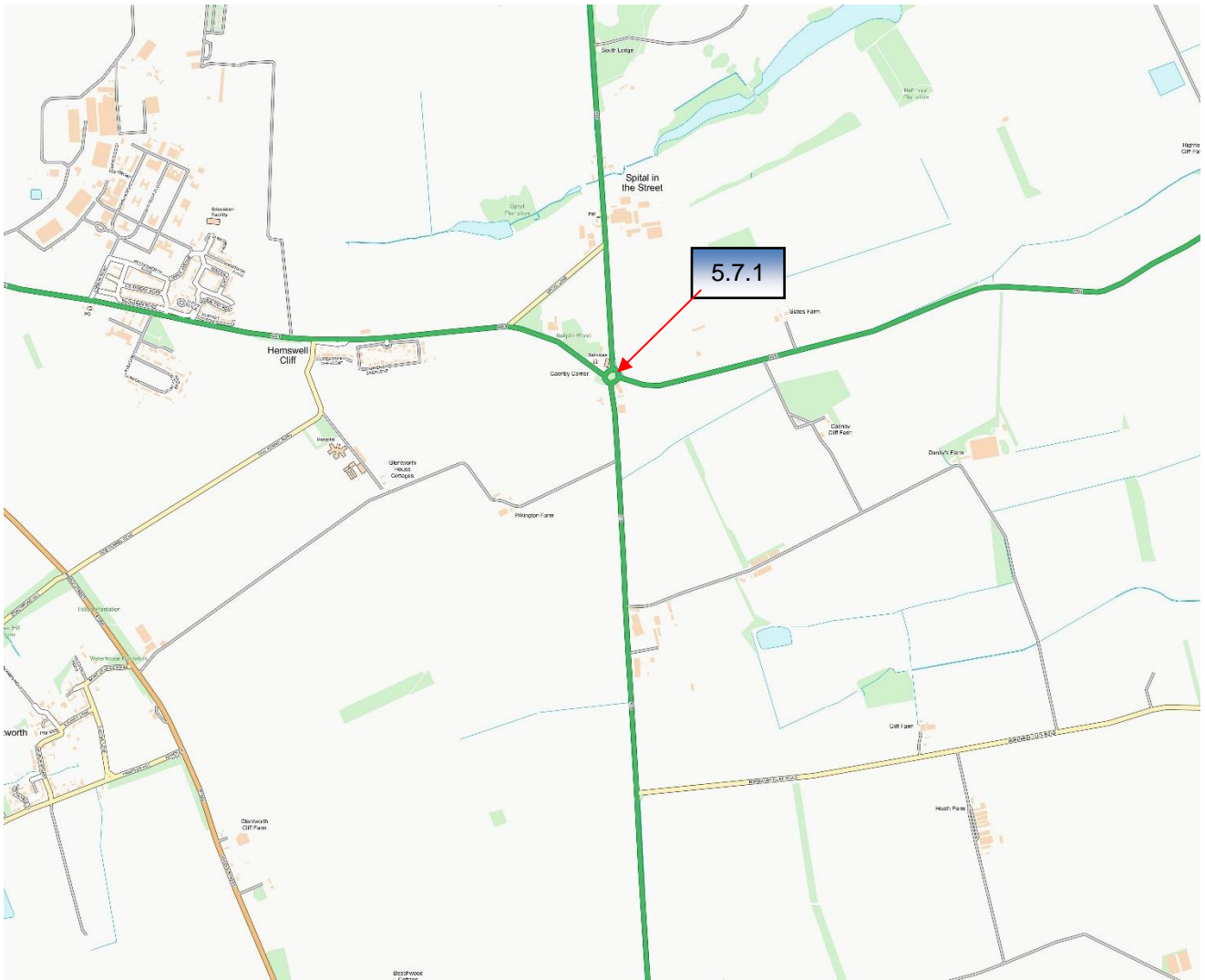

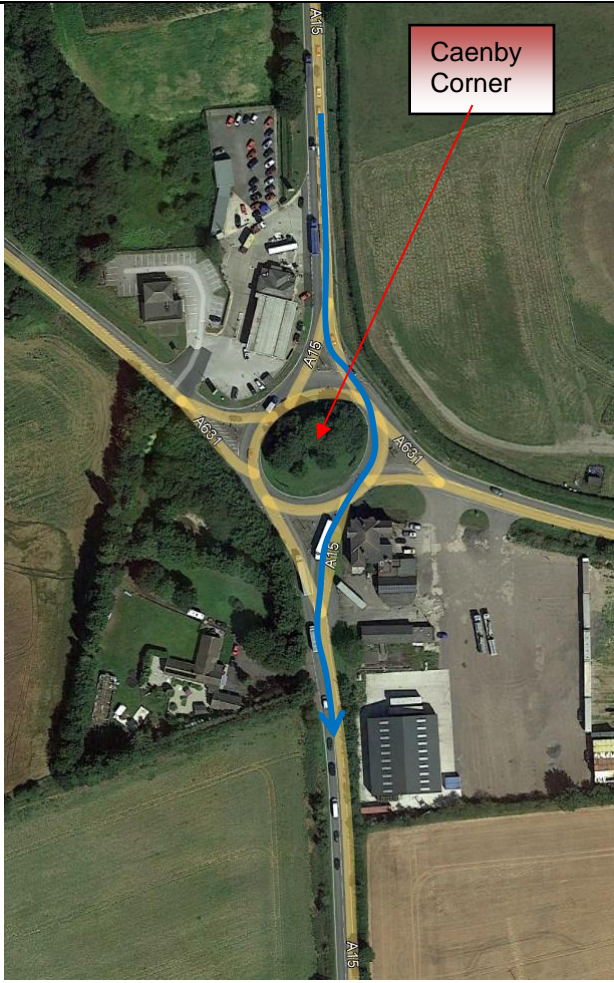
5.7. Map extract of survey locations



ITEM NUMBER	5.7.1		LOCATION	A15 Caenby Corner	
DIRECTION	At roundabout continue A15 2 nd Exit				
GRID REFERENCE	SK 96687 89439				
MODIFICATION AND DESCRIPTION			PHOTOGRAPH OF LOCATION		
<p>Visual inspection and swept path analysis indicates that the loaded vehicle will navigate this junction without any issues.</p>					
			View on approach to roundabout		
					
Aerial View of Location			View of exit from junction		
FURTHER INVESTIGATION UNDERTAKEN?			YES	TYPE	Swept Path Analysis
RELATED DOCUMENT NUMBERS			COL-D-373778-10-5		

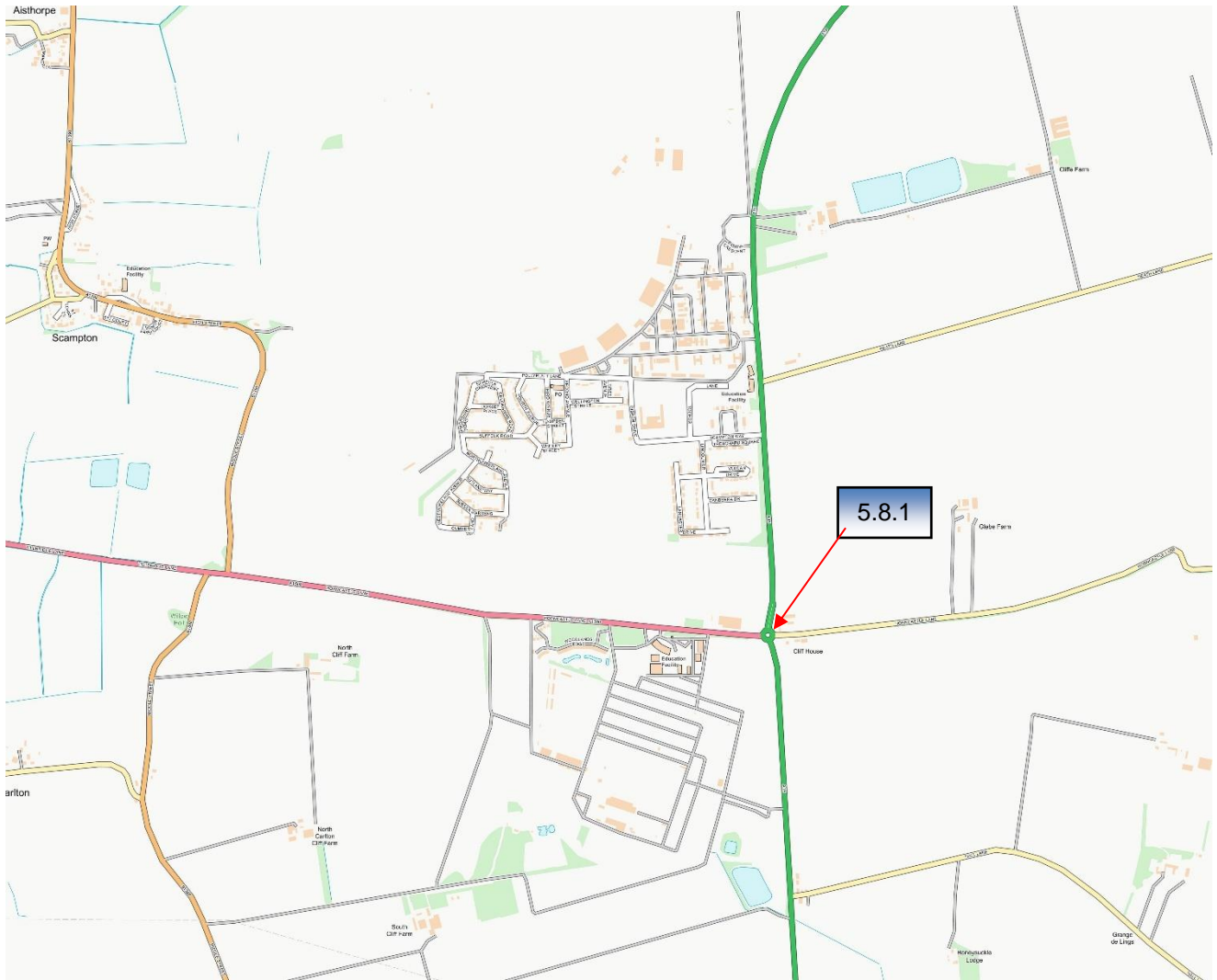

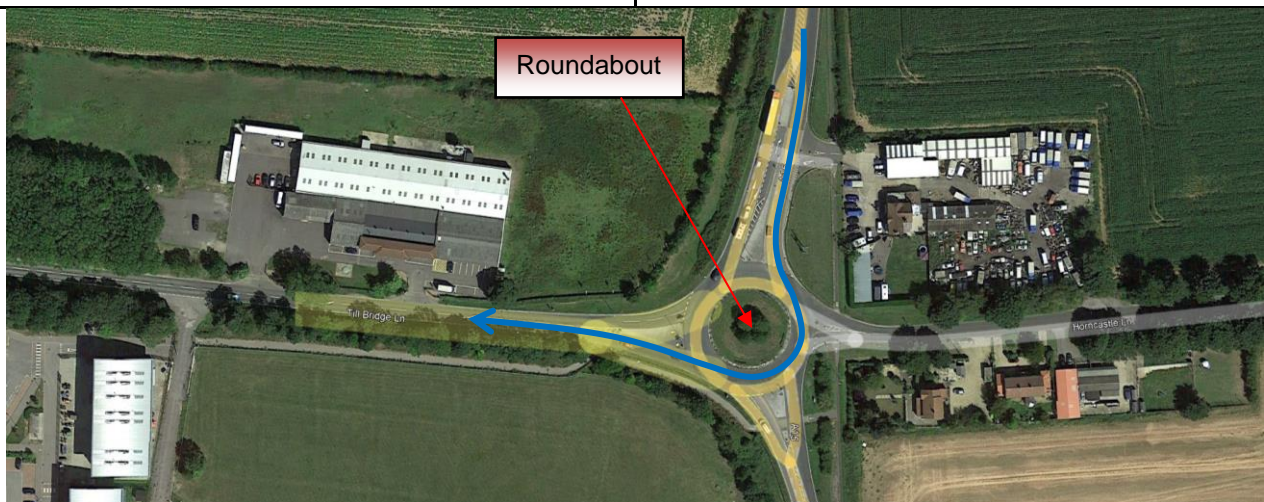

5.8. Map extract of survey locations









ITEM NUMBER	5.8.1		LOCATION	A15 / A1500 Roundabout	
DIRECTION	At roundabout turn right 3 rd exit onto A1500 Till Bridge Lane				
GRID REFERENCE	SK 97329 78115				
MODIFICATION AND DESCRIPTION			PHOTOGRAPH OF LOCATION		
<p>Visual inspection and Swept Path Analysis indicates that the loaded vehicle will navigate this roundabout without any issues.</p>					
			View on approach to roundabout		
					
View on roundabout			View of exit from roundabout		
					
Aerial View of Location					
FURTHER INVESTIGATION UNDERTAKEN?			YES	TYPE	Swept Path Analysis
RELATED DOCUMENT NUMBERS			COL-D-373778-10-6		

5.9. Map extract of survey locations

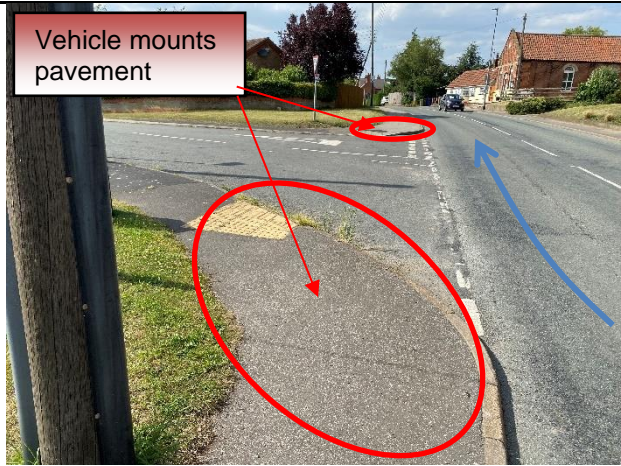
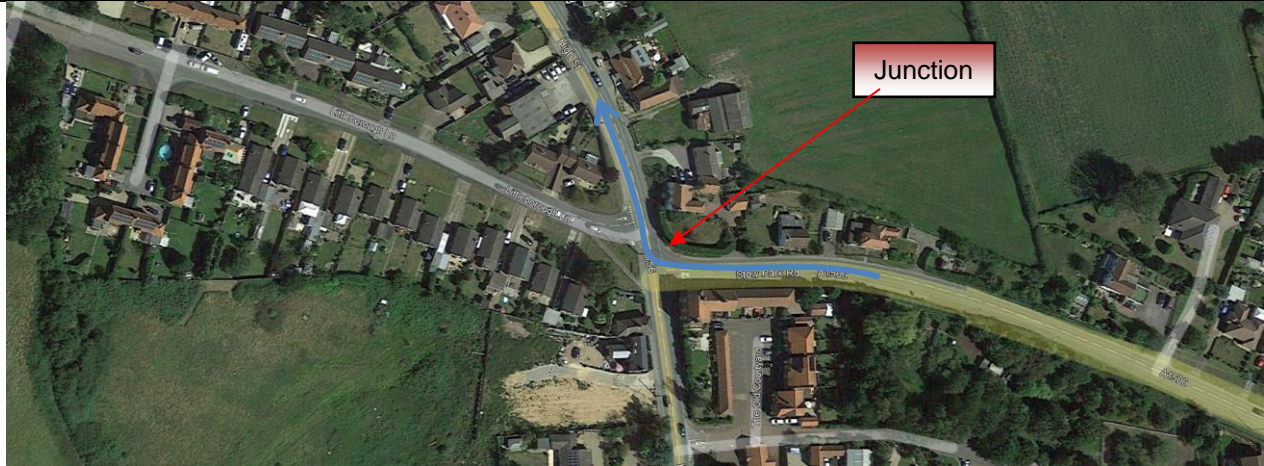

ITEM NUMBER	5.9.1	LOCATION	A1500 Marton / Hill Descent	
DIRECTION	Continue A1500 down the descent into Marton			
GRID REFERENCE	SK 84181 81978			
MODIFICATION AND DESCRIPTION		PHOTOGRAPH OF LOCATION		
<p>Visual inspection indicates that further analysis is required here. A vertical survey should be carried out to collect the data of the gradient to check if the vehicle is capable of negotiating down this descent.</p>				
		View on approach to the descent		
				
View looking up the descent		View towards the bottom of the descent		
				
Aerial View of Location				
FURTHER INVESTIGATION UNDERTAKEN?		NO	TYPE	N/A
RELATED DOCUMENT NUMBERS		N/A		

ITEM NUMBER	5.9.2		LOCATION	A1500 / A156 Marton	
DIRECTION	Turn right onto A156				
GRID REFERENCE	SK 84004 82020				
MODIFICATION AND DESCRIPTION			PHOTOGRAPH OF LOCATION		
<p>Visual inspection and Swept Path Analysis indicates that the loaded vehicle will mount the pavement here. The 2 pavements either side of the junction opposite may need to be protected and checked for vehicle loading.</p>					
			View on approach to junction		
					
View looking across junction			View of pavement opposite junction		
					
Aerial View of Location					
FURTHER INVESTIGATION UNDERTAKEN?			YES	TYPE	Swept Path Analysis
RELATED DOCUMENT NUMBERS			COL-D-373778-10-7		

ITEM NUMBER	5.9.3	LOCATION	A156 Gate Burton / Construction Access 1	
DIRECTION	Turn right from A156 into proposed Construction Access point 1			
GRID REFERENCE	SK 83041 84090			
MODIFICATION AND DESCRIPTION		PHOTOGRAPH OF LOCATION		
<p>Visual inspection indicates current road and terrain layout does not allow access for the delivery vehicle. Current access at this location is field access only. A larger access junction would have to be constructed to suit the path and turning radius of the vehicle.</p> <p>Exact access point at this location not confirmed during survey, but the 2 photos attached are the most likely access points.</p>		 <p>SK 83033 83953</p>		
		View of access point		
 <p>SK 83041 84090</p>				
View of access point		View of current track after photo to the left		
 <p>SK 83041 84090</p> <p>SK 83033 83953</p> <p>Construction Access 1</p>				
Aerial View of Location				
FURTHER INVESTIGATION UNDERTAKEN?		NO	TYPE	N/A
RELATED DOCUMENT NUMBERS		N/A		

6. Important Notes

- 6.1. The recommendations in this report are made from a purely transport orientated view, and do not consider any political issues in terms of land ownership, or any other precincts raised that may otherwise be restrictive.
- 6.2. The information contained in this report is private and confidential and is for the exclusive use of the client nominated herein.
- 6.3. A Police escort will be required in order to assist with traffic control for the entire route surveyed.
- 6.4. Special Order (BE16) Permits will be required for the movement of all loads. These permits are at the discretion of the National Highways (N.H) and Highways Scotland (H.S). Therefore, approval of these permits by the N.H & H.S is a major consideration before any movements can be undertaken.
- 6.5. It is recommended to have adequate warning signs implemented to warn other road users at critical points.
- 6.6. Areas where the loaded vehicle is to mount the pavement, suitable arrangements are to be made to protect the surface and any underground utilities that may be present. Including of ramping up to kerbs to avoid kerb & tyre damage, using sand bags or timbers.
- 6.7. Overhanging trees along the nominated routes must be trimmed to allow a suitable minimum envelope.
- 6.8. Specific street furniture has been nominated where necessary in this report to facilitate over-sailed and swept areas.
- 6.9. Overhead utility cables have not been measured as part of this survey and correspondence with the utility companies regarding cable heights and possible remedial solutions should be undertaken prior to any delivery.
- 6.10. It should be noted that all assessments and inspections have been done so with the intention of producing information to highlight anticipated problems. This includes highlighting of potential land take requirements, possible street furniture implications, and highway alignment issues.
- 6.11. Land take is usually referred to when land is required from private land owners; road widening is usually referred to when land is required within highways boundaries. The boundaries between private land and highways property are assumed by using obvious demarcation such as fence lines/hedges etc. It should be noted that actual boundaries between highways and private land are not substantiated in this report and can only be authenticated by carrying out land searches.
- 6.12. All inspections and assessments are made for the road movement of loaded trailer equipment carrying specific components. These dimensions are based on the turning circles and specification of Collett & Sons trailer equipment.
- 6.13. All route inspections and assessments, and subsequent conclusions and recommendations are deemed accurate by Collett & Sons Limited at the date that this report is created. We cannot be held responsible for the development of future road schemes or alterations to the routes surveyed that may leave this report inaccurate.
- 6.14. This report is based solely on a preliminary visual inspection. Nothing in this report shall be construed in any way as committing Collett & Sons Limited to being able to deliver to site using this route before further structural analysis has been undertaken, and any accommodation/remedial works undertaken which are to Collett & Sons satisfaction.

APPENDIX 1

LOADED CONFIGURATION DRAWINGS

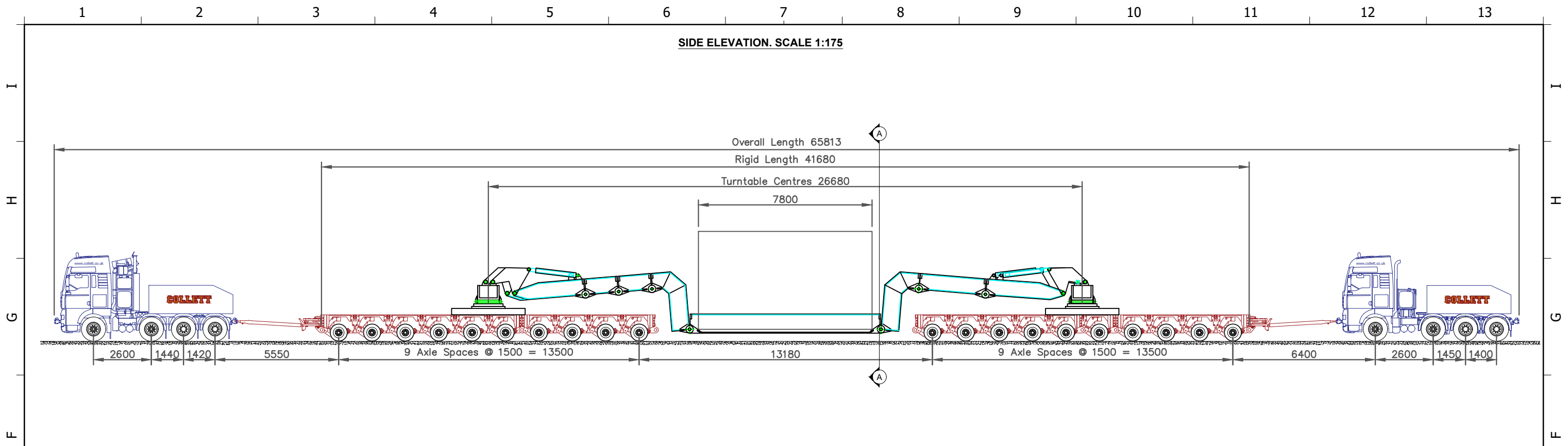

SECTION A-A. SCALE 1:50

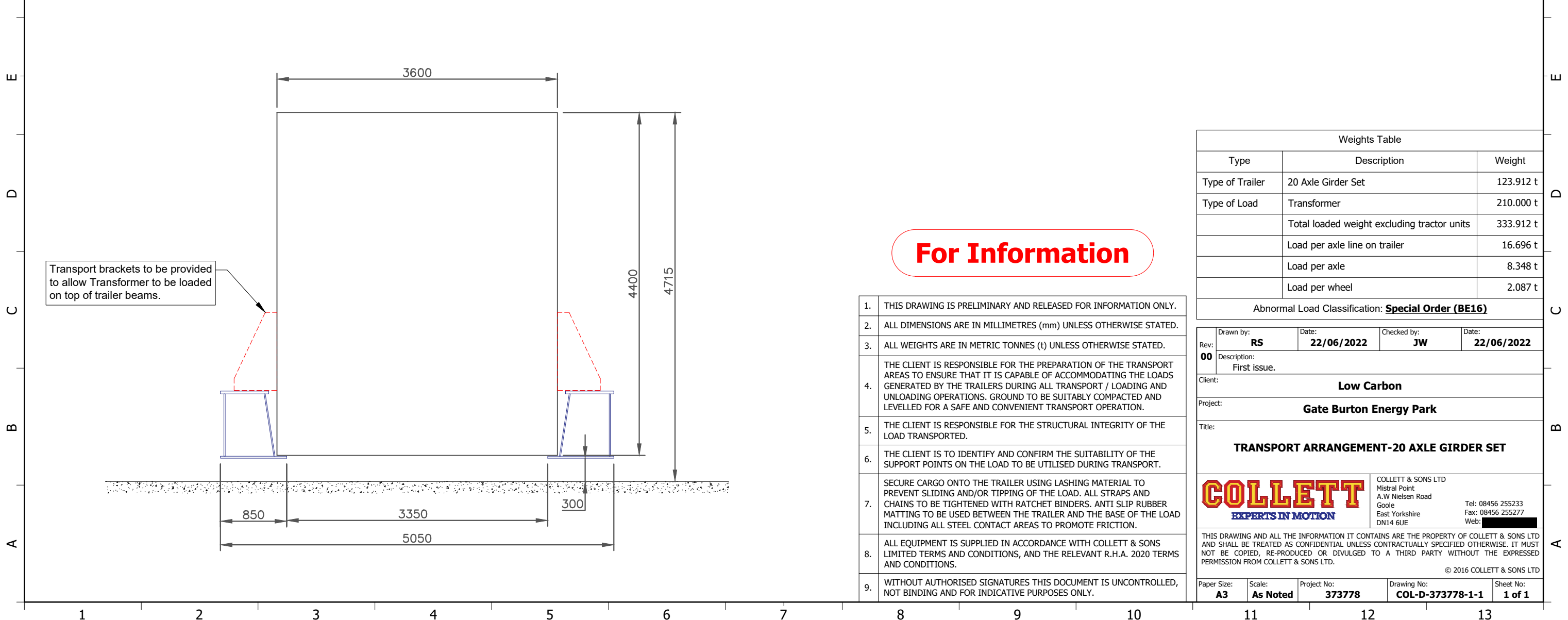

For Information

1. THIS DRAWING IS PRELIMINARY AND RELEASED FOR INFORMATION ONLY.
2. ALL DIMENSIONS ARE IN MILLIMETRES (mm) UNLESS OTHERWISE STATED.
3. ALL WEIGHTS ARE IN METRIC TONNES (t) UNLESS OTHERWISE STATED.
4. THE CLIENT IS RESPONSIBLE FOR THE PREPARATION OF THE TRANSPORT AREAS TO ENSURE THAT IT IS CAPABLE OF ACCOMMODATING THE LOADS GENERATED BY THE TRAILERS DURING ALL TRANSPORT / LOADING AND UNLOADING OPERATIONS. GROUND TO BE SUITABLY COMPACTED AND LEVELLED FOR A SAFE AND CONVENIENT TRANSPORT OPERATION.
5. THE CLIENT IS RESPONSIBLE FOR THE STRUCTURAL INTEGRITY OF THE LOAD TRANSPORTED.
6. THE CLIENT IS TO IDENTIFY AND CONFIRM THE SUITABILITY OF THE SUPPORT POINTS ON THE LOAD TO BE UTILISED DURING TRANSPORT.
7. SECURE CARGO ONTO THE TRAILER USING LASHING MATERIAL TO PREVENT SLIDING AND/OR TIPPING OF THE LOAD. ALL STRAPS AND CHAINS TO BE TIGHTENED WITH RATCHET BINDERS. ANTI SLIP RUBBER MATTING TO BE USED BETWEEN THE TRAILER AND THE BASE OF THE LOAD INCLUDING ALL STEEL CONTACT AREAS TO PROMOTE FRICTION.
8. ALL EQUIPMENT IS SUPPLIED IN ACCORDANCE WITH COLLETT & SONS LIMITED TERMS AND CONDITIONS, AND THE RELEVANT R.H.A. 2020 TERMS AND CONDITIONS.
9. WITHOUT AUTHORISED SIGNATURES THIS DOCUMENT IS UNCONTROLLED, NOT BINDING AND FOR INDICATIVE PURPOSES ONLY.

Weights Table		
Type	Description	Weight
Type of Trailer	20 Axle Girder Set	123.912 t
Type of Load	Transformer	210.000 t
	Total loaded weight excluding tractor units	333.912 t
	Load per axle line on trailer	16.696 t
	Load per axle	8.348 t
	Load per wheel	2.087 t
Abnormal Load Classification: Special Order (BE16)		

Drawn by:	Date:	Checked by:	Date:
RS	22/06/2022	JW	22/06/2022
Rev:	Description:		
00	First issue.		
Client:	Low Carbon		
Project:	Gate Burton Energy Park		
Title:	TRANSPORT ARRANGEMENT-20 AXLE GIRDER SET		
COLLETT EXPERTS IN MOTION		COLLETT & SONS LTD Mistral Point A.W Nielsen Road Goole East Yorkshire DN14 6UE Tel: 08456 255233 Fax: 08456 255277 Web: [REDACTED]	
THIS DRAWING AND ALL THE INFORMATION IT CONTAINS ARE THE PROPERTY OF COLLETT & SONS LTD AND SHALL BE TREATED AS CONFIDENTIAL UNLESS CONTRACTUALLY SPECIFIED OTHERWISE. IT MUST NOT BE COPIED, RE-PRODUCED OR DIVULGED TO A THIRD PARTY WITHOUT THE EXPRESSED PERMISSION FROM COLLETT & SONS LTD.			
Paper Size:	Scale:	Project No:	Drawing No:
A3	As Noted	373778	COL-D-373778-1-1
		Sheet No:	1 of 1

APPENDIX 2

SWEPT PATH ANALYSIS DRAWINGS

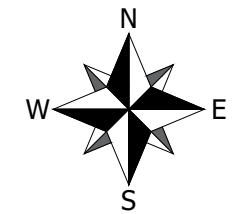
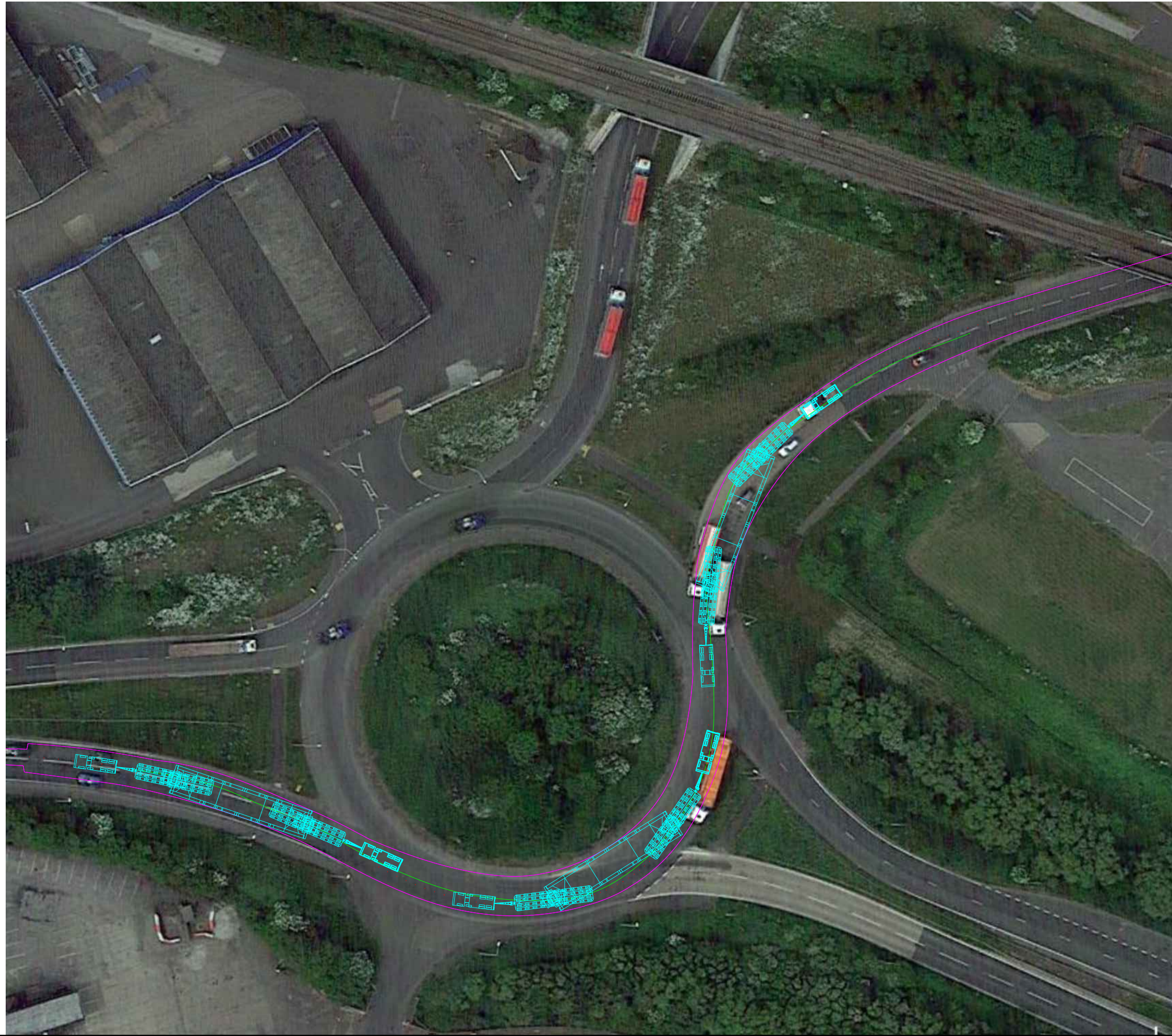

OS Grid Reference:	TA 17016 16612
Location:	Manby Roundabout
Vehicle:	20 Axle Girder Set.
Comments:	No issues with this SPA.

1. Magenta Line represents overall swept path areas over-sailed by trailer.
2. Green Line represents centre line of the independent manual steering geometry of rear bogie axles.
3. Red Dashed Line represents centre line of the pull truck.
4. Blue Line represents overall swept path areas over-sailed by Load.

For Information

1. THIS DRAWING IS PRELIMINARY AND RELEASED FOR INFORMATION ONLY.
2. ALL DIMENSIONS ARE IN MILLIMETRES (mm) UNLESS OTHERWISE STATED.
3. ALL WEIGHTS ARE IN METRIC TONNES (t) UNLESS OTHERWISE STATED.
4. THE CLIENT IS RESPONSIBLE FOR THE PREPARATION OF THE TRANSPORT AREAS TO ENSURE THAT IT IS CAPABLE OF ACCOMMODATING THE LOADS GENERATED BY THE TRAILERS DURING ALL TRANSPORT / LOADING AND UNLOADING OPERATIONS. GROUND TO BE SUITABLY COMPACTED AND LEVELLED FOR A SAFE AND CONVENIENT TRANSPORT OPERATION.
5. THE CLIENT IS RESPONSIBLE FOR THE STRUCTURAL INTEGRITY OF THE LOAD TRANSPORTED.
6. THE CLIENT IS TO IDENTIFY AND CONFIRM THE SUITABILITY OF THE SUPPORT POINTS ON THE LOAD TO BE UTILISED DURING TRANSPORT.
7. SECURE CARGO ONTO THE TRAILER USING LASHING MATERIAL TO PREVENT SLIDING AND/OR TIPPING OF THE LOAD. ALL STRAPS AND CHAINS TO BE TIGHTENED WITH RATCHET BINDERS. ANTI SLIP RUBBER MATTING TO BE USED BETWEEN THE TRAILER AND THE BASE OF THE LOAD INCLUDING ALL STEEL CONTACT AREAS TO PROMOTE FRICTION.
8. ALL EQUIPMENT IS SUPPLIED IN ACCORDANCE WITH COLLETT & SONS LIMITED TERMS AND CONDITIONS, AND THE RELEVANT R.H.A. 2020 TERMS AND CONDITIONS.
9. WITHOUT AUTHORISED SIGNATURES THIS DOCUMENT IS UNCONTROLLED, NOT BINDING AND FOR INDICATIVE PURPOSES ONLY.

Drawn by:	Date:	Checked by:	Date:
RM	21/06/2022	JW	21/06/2022
Rev:	Description:		
00	First issue.		

Client:	Low Carbon
Project:	Gate Burton Energy Park
Title:	SPA. Manby Roundabout

COLLETT EXPERTS IN MOTION	COLLETT & SONS LTD Mistral Point A.W Nielsen Road Goole East Yorkshire DN14 6UE	Tel: 08456 255233 Fax: 08456 255277 Web: www.collett.co.uk
-------------------------------------	------------------------------------------------------------------------------------------------	---------------------------------------------------------------------------------------------------------

THIS DRAWING AND ALL THE INFORMATION IT CONTAINS ARE THE PROPERTY OF COLLETT & SONS LTD AND SHALL BE TREATED AS CONFIDENTIAL UNLESS CONTRACTUALLY SPECIFIED OTHERWISE. IT MUST NOT BE COPIED, RE-PRODUCED OR DIVULGED TO A THIRD PARTY WITHOUT THE EXPRESSED PERMISSION FROM COLLETT & SONS LTD.

Paper Size:	Scale:	Project No:	Drawing No:	Sheet No:
A3	1:750	373778	COL-D-373778-10-1	1 of 1

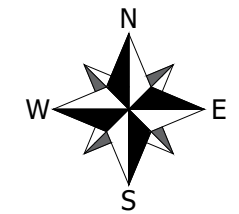
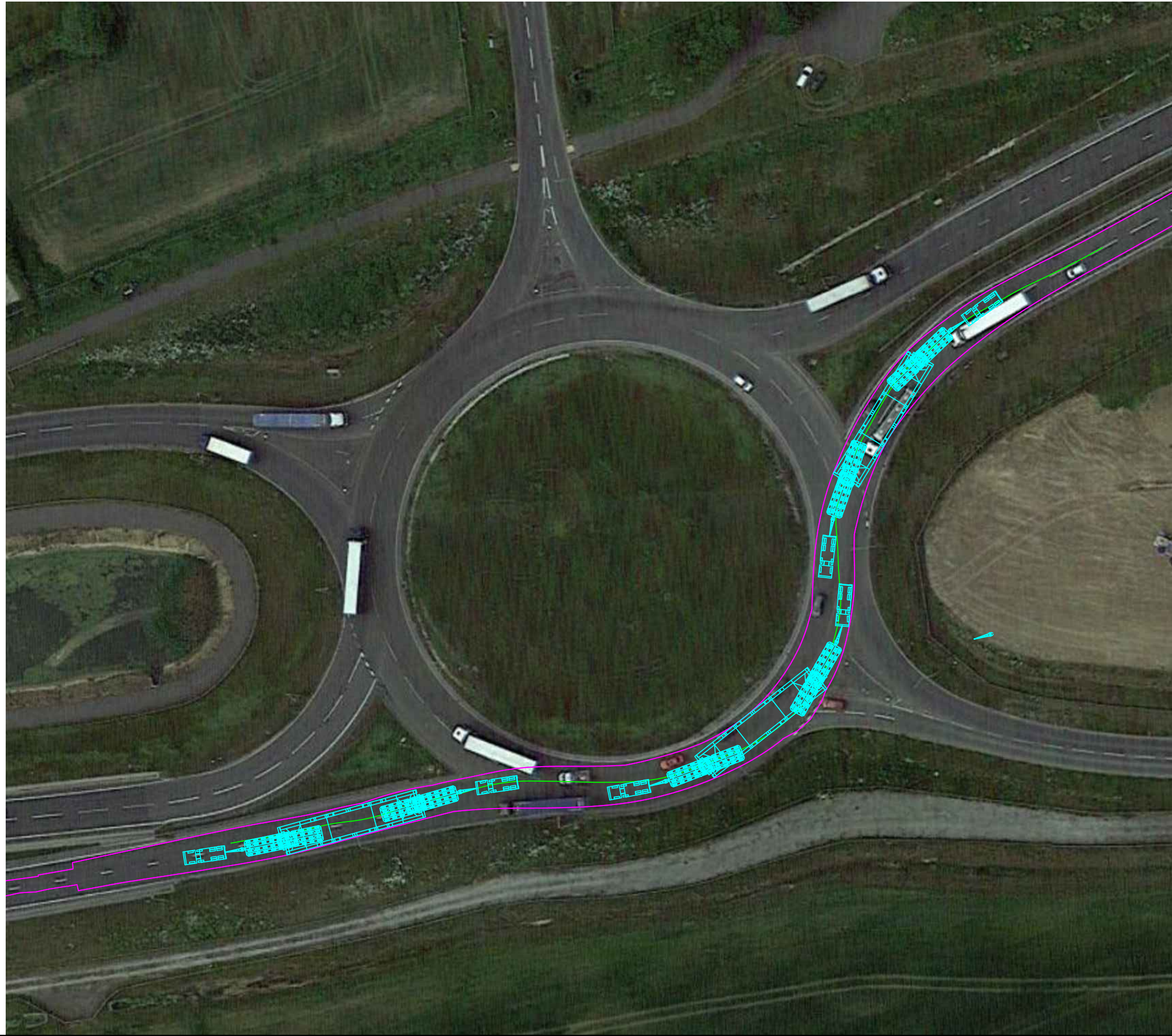

OS Grid Reference:	TA 14526 15798
Location:	Habrough Roundabout
Vehicle:	20 Axle Girder Set.
Comments:	No issues with this SPA.

1. Magenta Line represents overall swept path areas over-sailed by trailer.
2. Green Line represents centre line of the independent manual steering geometry of rear bogie axles.
3. Red Dashed Line represents centre line of the pull truck.
4. Blue Line represents overall swept path areas over-sailed by Load.

For Information

1. THIS DRAWING IS PRELIMINARY AND RELEASED FOR INFORMATION ONLY.
2. ALL DIMENSIONS ARE IN MILLIMETRES (mm) UNLESS OTHERWISE STATED.
3. ALL WEIGHTS ARE IN METRIC TONNES (t) UNLESS OTHERWISE STATED.
4. THE CLIENT IS RESPONSIBLE FOR THE PREPARATION OF THE TRANSPORT AREAS TO ENSURE THAT IT IS CAPABLE OF ACCOMMODATING THE LOADS GENERATED BY THE TRAILERS DURING ALL TRANSPORT / LOADING AND UNLOADING OPERATIONS. GROUND TO BE SUITABLY COMPACTED AND LEVELLED FOR A SAFE AND CONVENIENT TRANSPORT OPERATION.
5. THE CLIENT IS RESPONSIBLE FOR THE STRUCTURAL INTEGRITY OF THE LOAD TRANSPORTED.
6. THE CLIENT IS TO IDENTIFY AND CONFIRM THE SUITABILITY OF THE SUPPORT POINTS ON THE LOAD TO BE UTILISED DURING TRANSPORT.
7. SECURE CARGO ONTO THE TRAILER USING LASHING MATERIAL TO PREVENT SLIDING AND/OR TIPPING OF THE LOAD. ALL STRAPS AND CHAINS TO BE TIGHTENED WITH RATCHET BINDERS. ANTI SLIP RUBBER MATTING TO BE USED BETWEEN THE TRAILER AND THE BASE OF THE LOAD INCLUDING ALL STEEL CONTACT AREAS TO PROMOTE FRICTION.
8. ALL EQUIPMENT IS SUPPLIED IN ACCORDANCE WITH COLLETT & SONS LIMITED TERMS AND CONDITIONS, AND THE RELEVANT R.H.A. 2020 TERMS AND CONDITIONS.
9. WITHOUT AUTHORISED SIGNATURES THIS DOCUMENT IS UNCONTROLLED, NOT BINDING AND FOR INDICATIVE PURPOSES ONLY.

Drawn by:	Date:	Checked by:	Date:
RM	21/06/2022	JW	21/06/2022

Rev: **00** Description: First issue.

Client: **Low Carbon**

Project: **Gate Burton Energy Park**

Title: **SPA. Habrough Roundabout**

	COLLETT & SONS LTD Mistral Point A.W Nielsen Road Goole East Yorkshire DN14 6UE Tel: 08456 255233 Fax: 08456 255277 Web: www.collett.co.uk
--	-----------------------------------------------------------------------------------------------------------------------------------------------------------------------------------------------------------

THIS DRAWING AND ALL THE INFORMATION IT CONTAINS ARE THE PROPERTY OF COLLETT & SONS LTD AND SHALL BE TREATED AS CONFIDENTIAL UNLESS CONTRACTUALLY SPECIFIED OTHERWISE. IT MUST NOT BE COPIED, RE-PRODUCED OR DIVULGED TO A THIRD PARTY WITHOUT THE EXPRESSED PERMISSION FROM COLLETT & SONS LTD.

© 2016 COLLETT & SONS LTD

Paper Size:	Scale:	Project No:	Drawing No:	Sheet No:
A3	1:750	373778	COL-D-373778-10-2	1 of 1

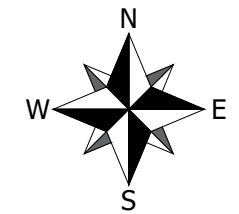

OS Grid Reference:	TA 13691 14485
Location:	Brocklesby Interchange
Vehicle:	20 Axle Girder Set.
Comments:	No issues with this SPA.

1. Magenta Line represents overall swept path areas over-sailed by trailer.
2. Green Line represents centre line of the independent manual steering geometry of rear bogie axles.
3. Red Dashed Line represents centre line of the pull truck.
4. Blue Line represents overall swept path areas over-sailed by Load.

For Information

1. THIS DRAWING IS PRELIMINARY AND RELEASED FOR INFORMATION ONLY.
2. ALL DIMENSIONS ARE IN MILLIMETRES (mm) UNLESS OTHERWISE STATED.
3. ALL WEIGHTS ARE IN METRIC TONNES (t) UNLESS OTHERWISE STATED.
4. THE CLIENT IS RESPONSIBLE FOR THE PREPARATION OF THE TRANSPORT AREAS TO ENSURE THAT IT IS CAPABLE OF ACCOMMODATING THE LOADS GENERATED BY THE TRAILERS DURING ALL TRANSPORT / LOADING AND UNLOADING OPERATIONS. GROUND TO BE SUITABLY COMPACTED AND LEVELLED FOR A SAFE AND CONVENIENT TRANSPORT OPERATION.
5. THE CLIENT IS RESPONSIBLE FOR THE STRUCTURAL INTEGRITY OF THE LOAD TRANSPORTED.
6. THE CLIENT IS TO IDENTIFY AND CONFIRM THE SUITABILITY OF THE SUPPORT POINTS ON THE LOAD TO BE UTILISED DURING TRANSPORT.
7. SECURE CARGO ONTO THE TRAILER USING LASHING MATERIAL TO PREVENT SLIDING AND/OR TIPPING OF THE LOAD. ALL STRAPS AND CHAINS TO BE TIGHTENED WITH RATCHET BINDERS. ANTI SLIP RUBBER MATTING TO BE USED BETWEEN THE TRAILER AND THE BASE OF THE LOAD INCLUDING ALL STEEL CONTACT AREAS TO PROMOTE FRICTION.
8. ALL EQUIPMENT IS SUPPLIED IN ACCORDANCE WITH COLLETT & SONS LIMITED TERMS AND CONDITIONS, AND THE RELEVANT R.H.A. 2020 TERMS AND CONDITIONS.
9. WITHOUT AUTHORISED SIGNATURES THIS DOCUMENT IS UNCONTROLLED, NOT BINDING AND FOR INDICATIVE PURPOSES ONLY.

Drawn by:	Date:	Checked by:	Date:
RM	21/06/2022	JW	21/06/2022
Rev: 00	Description: First issue.		

Client: **Low Carbon**

Project: **Gate Burton Energy Park**

Title: **SPA. Brocklesby Interchange**

COLLETT <small>EXPERTS IN MOTION</small>	COLLETT & SONS LTD Mistral Point A.W Nielsen Road Goole East Yorkshire DN14 6UE	Tel: 08456 255233 Fax: 08456 255277 Web: www.collett.co.uk
	THIS DRAWING AND ALL THE INFORMATION IT CONTAINS ARE THE PROPERTY OF COLLETT & SONS LTD AND SHALL BE TREATED AS CONFIDENTIAL UNLESS CONTRACTUALLY SPECIFIED OTHERWISE. IT MUST NOT BE COPIED, RE-PRODUCED OR DIVULGED TO A THIRD PARTY WITHOUT THE EXPRESSED PERMISSION FROM COLLETT & SONS LTD.	

© 2016 COLLETT & SONS LTD

Paper Size:	Scale:	Project No:	Drawing No:	Sheet No:
A3	1:1000	373778	COL-D-373778-10-3	1 of 1

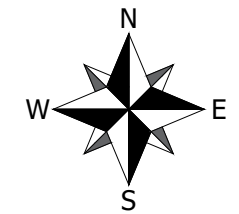
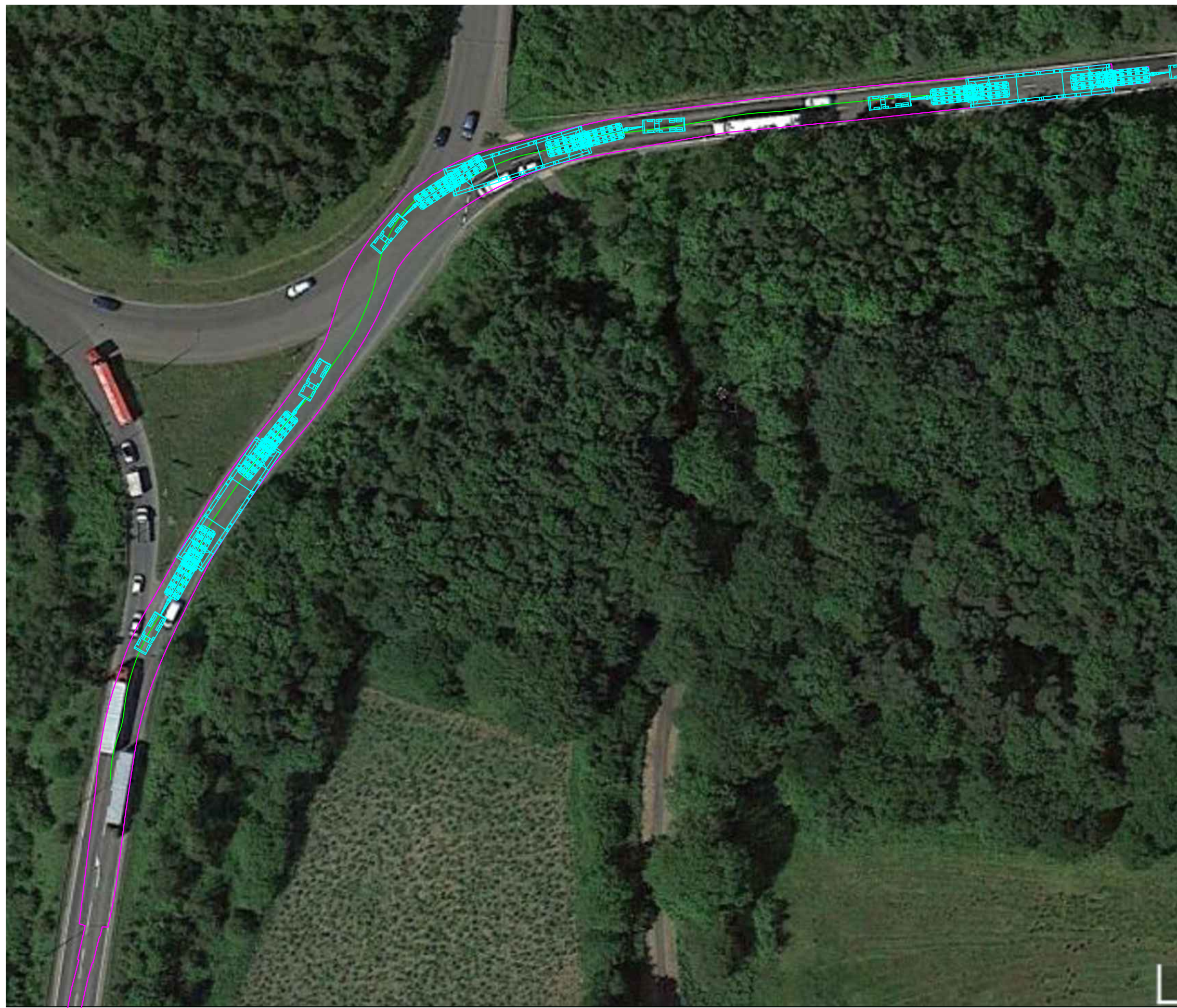

OS Grid Reference:	SE 95646 06235
Location:	Turn left from M180 into A15
Vehicle:	20 Axle Girder Set.
Comments:	No issues with this SPA.

1. Magenta Line represents overall swept path areas over-sailed by trailer.
2. Green Line represents centre line of the independent manual steering geometry of rear bogie axles.
3. Red Dashed Line represents centre line of the pull truck.
4. Blue Line represents overall swept path areas over-sailed by Load.

For Information

1. THIS DRAWING IS PRELIMINARY AND RELEASED FOR INFORMATION ONLY.
2. ALL DIMENSIONS ARE IN MILLIMETRES (mm) UNLESS OTHERWISE STATED.
3. ALL WEIGHTS ARE IN METRIC TONNES (t) UNLESS OTHERWISE STATED.
4. THE CLIENT IS RESPONSIBLE FOR THE PREPARATION OF THE TRANSPORT AREAS TO ENSURE THAT IT IS CAPABLE OF ACCOMMODATING THE LOADS GENERATED BY THE TRAILERS DURING ALL TRANSPORT / LOADING AND UNLOADING OPERATIONS. GROUND TO BE SUITABLY COMPACTED AND LEVELLED FOR A SAFE AND CONVENIENT TRANSPORT OPERATION.
5. THE CLIENT IS RESPONSIBLE FOR THE STRUCTURAL INTEGRITY OF THE LOAD TRANSPORTED.
6. THE CLIENT IS TO IDENTIFY AND CONFIRM THE SUITABILITY OF THE SUPPORT POINTS ON THE LOAD TO BE UTILISED DURING TRANSPORT.
7. SECURE CARGO ONTO THE TRAILER USING LASHING MATERIAL TO PREVENT SLIDING AND/OR TIPPING OF THE LOAD. ALL STRAPS AND CHAINS TO BE TIGHTENED WITH RATCHET BINDERS. ANTI SLIP RUBBER MATTING TO BE USED BETWEEN THE TRAILER AND THE BASE OF THE LOAD INCLUDING ALL STEEL CONTACT AREAS TO PROMOTE FRICTION.
8. ALL EQUIPMENT IS SUPPLIED IN ACCORDANCE WITH COLLETT & SONS LIMITED TERMS AND CONDITIONS, AND THE RELEVANT R.H.A. 2020 TERMS AND CONDITIONS.
9. WITHOUT AUTHORISED SIGNATURES THIS DOCUMENT IS UNCONTROLLED, NOT BINDING AND FOR INDICATIVE PURPOSES ONLY.

Drawn by:	Date:	Checked by:	Date:
RM	21/06/2022	JW	21/06/2022
Rev: 00	Description: First issue.		

Client: **Low Carbon**

Project: **Gate Burton Energy Park**

Title: **SPA. Turn left from M180 into A15**

COLLETT EXPERTS IN MOTION	COLLETT & SONS LTD Mistral Point A.W Nielsen Road Goole East Yorkshire DN14 6UE	Tel: 08456 255233 Fax: 08456 255277 Web: www.collett.co.uk
-------------------------------------	------------------------------------------------------------------------------------------------	---------------------------------------------------------------------------------------------------------

THIS DRAWING AND ALL THE INFORMATION IT CONTAINS ARE THE PROPERTY OF COLLETT & SONS LTD AND SHALL BE TREATED AS CONFIDENTIAL UNLESS CONTRACTUALLY SPECIFIED OTHERWISE. IT MUST NOT BE COPIED, RE-PRODUCED OR DIVULGED TO A THIRD PARTY WITHOUT THE EXPRESSED PERMISSION FROM COLLETT & SONS LTD.

Paper Size:	Scale:	Project No:	Drawing No:	Sheet No:
A3	1:750	373778	COL-D-373778-10-4	1 of 1

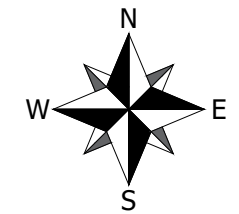
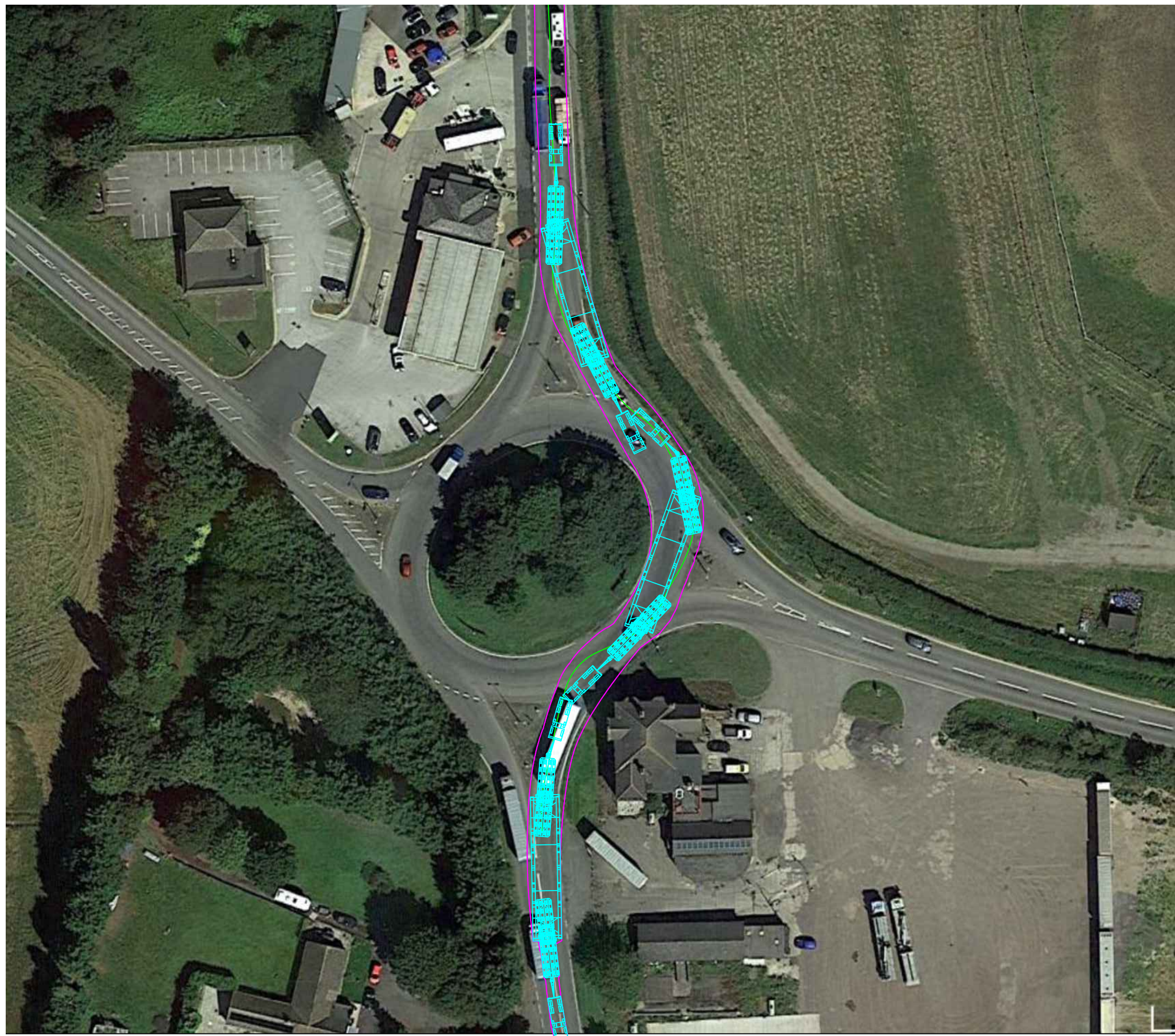

OS Grid Reference:	SK 96687 89439
Location:	Caenby Corner Roundabout
Vehicle:	20 Axle Girder Set.
Comments:	No issues with this SPA.

1. Magenta Line represents overall swept path areas over-sailed by trailer.
2. Green Line represents centre line of the independent manual steering geometry of rear bogie axles.
3. Red Dashed Line represents centre line of the pull truck.
4. Blue Line represents overall swept path areas over-sailed by Load.

For Information

1. THIS DRAWING IS PRELIMINARY AND RELEASED FOR INFORMATION ONLY.
2. ALL DIMENSIONS ARE IN MILLIMETRES (mm) UNLESS OTHERWISE STATED.
3. ALL WEIGHTS ARE IN METRIC TONNES (t) UNLESS OTHERWISE STATED.
4. THE CLIENT IS RESPONSIBLE FOR THE PREPARATION OF THE TRANSPORT AREAS TO ENSURE THAT IT IS CAPABLE OF ACCOMMODATING THE LOADS GENERATED BY THE TRAILERS DURING ALL TRANSPORT / LOADING AND UNLOADING OPERATIONS. GROUND TO BE SUITABLY COMPACTED AND LEVELLED FOR A SAFE AND CONVENIENT TRANSPORT OPERATION.
5. THE CLIENT IS RESPONSIBLE FOR THE STRUCTURAL INTEGRITY OF THE LOAD TRANSPORTED.
6. THE CLIENT IS TO IDENTIFY AND CONFIRM THE SUITABILITY OF THE SUPPORT POINTS ON THE LOAD TO BE UTILISED DURING TRANSPORT.
7. SECURE CARGO ONTO THE TRAILER USING LASHING MATERIAL TO PREVENT SLIDING AND/OR TIPPING OF THE LOAD. ALL STRAPS AND CHAINS TO BE TIGHTENED WITH RATCHET BINDERS. ANTI SLIP RUBBER MATTING TO BE USED BETWEEN THE TRAILER AND THE BASE OF THE LOAD INCLUDING ALL STEEL CONTACT AREAS TO PROMOTE FRICTION.
8. ALL EQUIPMENT IS SUPPLIED IN ACCORDANCE WITH COLLETT & SONS LIMITED TERMS AND CONDITIONS, AND THE RELEVANT R.H.A. 2020 TERMS AND CONDITIONS.
9. WITHOUT AUTHORISED SIGNATURES THIS DOCUMENT IS UNCONTROLLED, NOT BINDING AND FOR INDICATIVE PURPOSES ONLY.

Drawn by:	Date:	Checked by:	Date:
RM	21/06/2022	JW	21/06/2022
Rev: 00 Description: First issue.			
Client: Low Carbon			
Project: Gate Burton Energy Park			
Title: SPA. Caenby Corner Roundabout			

COLLETT <small>EXPERTS IN MOTION</small>	COLLETT & SONS LTD Mistral Point A.W Nielsen Road Goole East Yorkshire DN14 6UE	Tel: 08456 255233 Fax: 08456 255277 Web: www.collett.co.uk
	THIS DRAWING AND ALL THE INFORMATION IT CONTAINS ARE THE PROPERTY OF COLLETT & SONS LTD AND SHALL BE TREATED AS CONFIDENTIAL UNLESS CONTRACTUALLY SPECIFIED OTHERWISE. IT MUST NOT BE COPIED, RE-PRODUCED OR DIVULGED TO A THIRD PARTY WITHOUT THE EXPRESSED PERMISSION FROM COLLETT & SONS LTD.	

© 2016 COLLETT & SONS LTD

Paper Size:	Scale:	Project No:	Drawing No:	Sheet No:
A3	1:750	373778	COL-D-373778-10-5	1 of 1

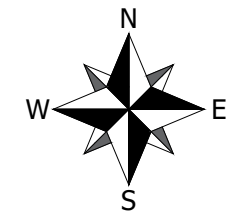

OS Grid Reference:	SK 97329 78115
Location:	Scampton CP Roundabout
Vehicle:	20 Axle Girder Set.
Comments:	No issues with this SPA.

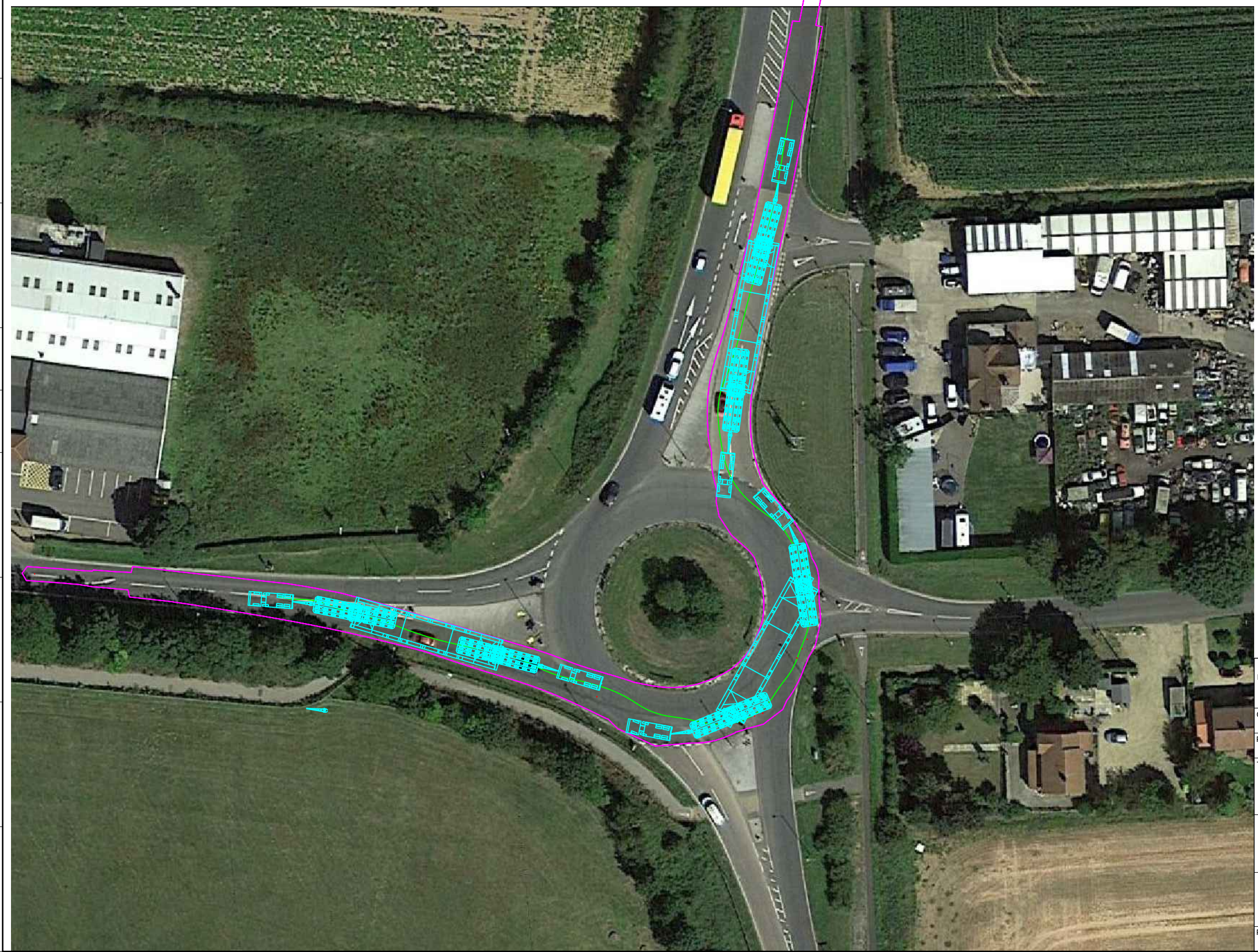

1. Magenta Line represents overall swept path areas over-sailed by trailer.
2. Green Line represents centre line of the independent manual steering geometry of rear bogie axles.
3. Red Dashed Line represents centre line of the pull truck.
4. Blue Line represents overall swept path areas over-sailed by Load.

For Information

1. THIS DRAWING IS PRELIMINARY AND RELEASED FOR INFORMATION ONLY.
2. ALL DIMENSIONS ARE IN MILLIMETRES (mm) UNLESS OTHERWISE STATED.
3. ALL WEIGHTS ARE IN METRIC TONNES (t) UNLESS OTHERWISE STATED.
4. THE CLIENT IS RESPONSIBLE FOR THE PREPARATION OF THE TRANSPORT AREAS TO ENSURE THAT IT IS CAPABLE OF ACCOMMODATING THE LOADS GENERATED BY THE TRAILERS DURING ALL TRANSPORT / LOADING AND UNLOADING OPERATIONS. GROUND TO BE SUITABLY COMPACTED AND LEVELLED FOR A SAFE AND CONVENIENT TRANSPORT OPERATION.
5. THE CLIENT IS RESPONSIBLE FOR THE STRUCTURAL INTEGRITY OF THE LOAD TRANSPORTED.
6. THE CLIENT IS TO IDENTIFY AND CONFIRM THE SUITABILITY OF THE SUPPORT POINTS ON THE LOAD TO BE UTILISED DURING TRANSPORT.
7. SECURE CARGO ONTO THE TRAILER USING LASHING MATERIAL TO PREVENT SLIDING AND/OR TIPPING OF THE LOAD. ALL STRAPS AND CHAINS TO BE TIGHTENED WITH RATCHET BINDERS. ANTI SLIP RUBBER MATTING TO BE USED BETWEEN THE TRAILER AND THE BASE OF THE LOAD INCLUDING ALL STEEL CONTACT AREAS TO PROMOTE FRICTION.
8. ALL EQUIPMENT IS SUPPLIED IN ACCORDANCE WITH COLLETT & SONS LIMITED TERMS AND CONDITIONS, AND THE RELEVANT R.H.A. 2020 TERMS AND CONDITIONS.
9. WITHOUT AUTHORISED SIGNATURES THIS DOCUMENT IS UNCONTROLLED, NOT BINDING AND FOR INDICATIVE PURPOSES ONLY.

Drawn by:	Date:	Checked by:	Date:
RM	21/06/2022	JW	21/06/2022
Rev: 00	Description: First issue.		

Client:	Low Carbon
Project:	Gate Burton Energy Park
Title:	SPA. Scampton CP Roundabout

	COLLETT & SONS LTD Mistral Point A.W Nielsen Road Goole East Yorkshire DN14 6UE	Tel: 08456 255233 Fax: 08456 255277 Web: www.collett.co.uk
--	------------------------------------------------------------------------------------------------	---------------------------------------------------------------------------------------------------------

THIS DRAWING AND ALL THE INFORMATION IT CONTAINS ARE THE PROPERTY OF COLLETT & SONS LTD AND SHALL BE TREATED AS CONFIDENTIAL UNLESS CONTRACTUALLY SPECIFIED OTHERWISE. IT MUST NOT BE COPIED, RE-PRODUCED OR DIVULGED TO A THIRD PARTY WITHOUT THE EXPRESSED PERMISSION FROM COLLETT & SONS LTD.

Paper Size:	Scale:	Project No:	Drawing No:	Sheet No:
A3	1:750	373778	COL-D-373778-10-6	1 of 1

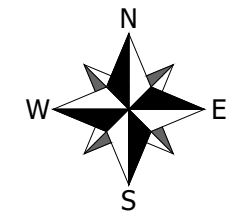

OS Grid Reference:	SK 84004 82020
Location:	Turn right from stow park RD to A156
Vehicle:	20 Axle Girder Set.
Comments:	The vehicle mounts the pavement at the 2 locations at the junction opposite

1. Magenta Line represents overall swept path areas over-sailed by trailer.
2. Green Line represents centre line of the independent manual steering geometry of rear bogie axles.
3. Red Dashed Line represents centre line of the pull truck.
4. Blue Line represents overall swept path areas over-sailed by Load.

For Information

1. THIS DRAWING IS PRELIMINARY AND RELEASED FOR INFORMATION ONLY.
2. ALL DIMENSIONS ARE IN MILLIMETRES (mm) UNLESS OTHERWISE STATED.
3. ALL WEIGHTS ARE IN METRIC TONNES (t) UNLESS OTHERWISE STATED.
4. THE CLIENT IS RESPONSIBLE FOR THE PREPARATION OF THE TRANSPORT AREAS TO ENSURE THAT IT IS CAPABLE OF ACCOMMODATING THE LOADS GENERATED BY THE TRAILERS DURING ALL TRANSPORT / LOADING AND UNLOADING OPERATIONS. GROUND TO BE SUITABLY COMPACTED AND LEVELLED FOR A SAFE AND CONVENIENT TRANSPORT OPERATION.
5. THE CLIENT IS RESPONSIBLE FOR THE STRUCTURAL INTEGRITY OF THE LOAD TRANSPORTED.
6. THE CLIENT IS TO IDENTIFY AND CONFIRM THE SUITABILITY OF THE SUPPORT POINTS ON THE LOAD TO BE UTILISED DURING TRANSPORT.
7. SECURE CARGO ONTO THE TRAILER USING LASHING MATERIAL TO PREVENT SLIDING AND/OR TIPPING OF THE LOAD. ALL STRAPS AND CHAINS TO BE TIGHTENED WITH RATCHET BINDERS. ANTI SLIP RUBBER MATTING TO BE USED BETWEEN THE TRAILER AND THE BASE OF THE LOAD INCLUDING ALL STEEL CONTACT AREAS TO PROMOTE FRICTION.
8. ALL EQUIPMENT IS SUPPLIED IN ACCORDANCE WITH COLLETT & SONS LIMITED TERMS AND CONDITIONS, AND THE RELEVANT R.H.A. 2020 TERMS AND CONDITIONS.
9. WITHOUT AUTHORISED SIGNATURES THIS DOCUMENT IS UNCONTROLLED, NOT BINDING AND FOR INDICATIVE PURPOSES ONLY.

Drawn by:	Date:	Checked by:	Date:
RM	21/06/2022	JW	21/06/2022
Rev: 00	Description: First issue.		

Client:	Low Carbon
Project:	Gate Burton Energy Park
Title:	SPA. Turn right from stow park road into A156

COLLETT EXPERTS IN MOTION	COLLETT & SONS LTD Mistral Point A.W Nielsen Road Goole East Yorkshire DN14 6UE	Tel: 08456 255233 Fax: 08456 255277 Web: www.collett.co.uk
-------------------------------------	------------------------------------------------------------------------------------------------	---------------------------------------------------------------------------------------------------------

THIS DRAWING AND ALL THE INFORMATION IT CONTAINS ARE THE PROPERTY OF COLLETT & SONS LTD AND SHALL BE TREATED AS CONFIDENTIAL UNLESS CONTRACTUALLY SPECIFIED OTHERWISE. IT MUST NOT BE COPIED, RE-PRODUCED OR DIVULGED TO A THIRD PARTY WITHOUT THE EXPRESSED PERMISSION FROM COLLETT & SONS LTD.

Paper Size:	Scale:	Project No:	Drawing No:	Sheet No:
A3	1:500	373778	COL-D-373778-10-7	1 of 1